

UXR™ -300BF SERIES

CERAMIC XENON LAMPS

The USHIO UXR™ Ceramic Xenon lamps are highly efficient, pre-aligned, parabolic reflectorized lamps for use in numerous scientific, medical and industrial illumination applications. The UXR features strong output reliability over life, highly stable 6100K color temperature, a compact and rugged ceramic to metal seal manufactured body and new window protection design. Manufactured at our ISO-certified plant, all UXR lamps are built to high quality standards for consistent and reliable performance.

FEATURES & BENEFITS:

- Rugged Compact Design
- Broad Continuous Spectral Output, High Color Rendering
- Superior Lumen Maintenance with Improved Ignition Reliability
- Demanding Quality Control and Manufacturing Aspects Produce Highly Consistent Lamp to Lamp Replacement Performance
- New Window Design Protects Against Scratching and Surface Contamination



APPLICATIONS:

- Endoscopy
- Surgical Headlights
- Microscopy
- Borescopy
- Spectroscopy
- Visible/Infrared Searchlights
- Machine Vision
- Solar Simulation
- Projection

USHIO

UXR™ -300BF XENON SHORT ARC

UXR-300BF ITEM# 5002534

ELECTRICAL CHARACTERISTICS

Watts (W)	300
Voltage (V)	15
Current (A)	20
Current Range (A)	18~21

SPECIFICATIONS

Arc Gap (mm)	1.5
Spectral Type	Ozone Free
Window Diameter (mm)	ø25.4
Reflector	Parabola
Rated Life (h)	500
Lifetime* (h)	1000

INITIAL OUTPUT

Radiant Output (W)	50
Visible Output (lm)	4500
Visible Output (5mm Aperture)(lm)	1830
Color Temperature (K)	6100

OPERATING CONDITION (Lamp)

Burn Position	Horizontal
Ceramic Body Temperature	Max. 150°
Base Temperature	Max. 200°
Forced Cooling	Necessary

OPERATING CONDITION (Power Supply)

Control	Constant Current & Power Control
Current Ripple (P-P)	Max 5%
Igniter Voltage	Min. AC23kV
Supply Voltage	Min. 140V

* Visible output (5mm aperture) is reduced to 50% of the initial value.

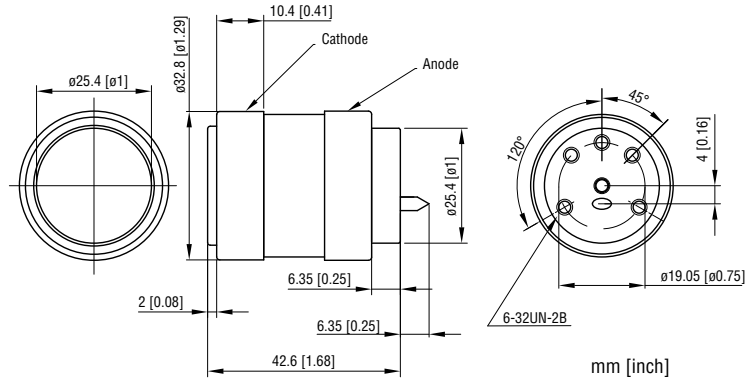

Visible Output (5mm Aperture) Degradation

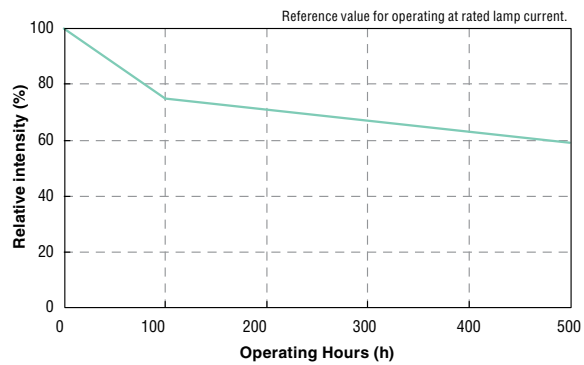

Spectral Distribution

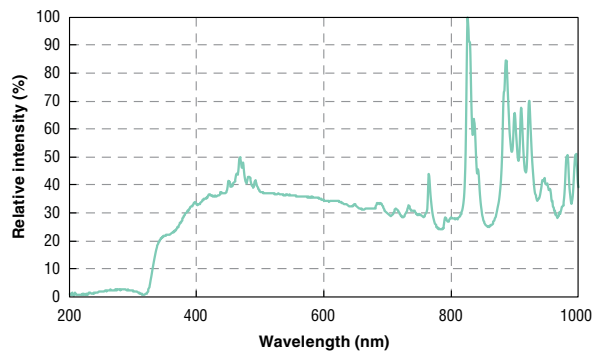

Ordinary Lamps

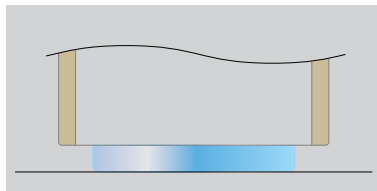

This drawing illustrates window contact on a surface which can cause window scratches and contamination.

UXR Series

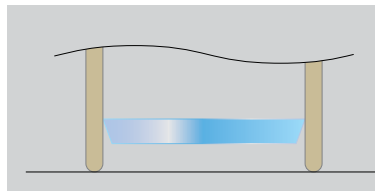





USHIO's UXR unique lamp design protects the front window from surface contact to help prevent scratching and contamination.



Safety Instructions



WARNING

-  High internal pressure exists in the lamp. Do not apply any excessive shock, stress or scratch the lamp while handling. Damage to the lamp may result in catastrophic failure.
-  Lamp should not be operated in a vertical position and with the window in an up position. Such orientation may result in high thermal stress and window failure.
-  Turn off the power before inserting, removing or cleaning the lamp to prevent electrical shock.
-  High voltage is required for ignition. Do not touch the lamp or heat sinks during operation, especially at the start of ignition.
-  Do not look directly at the operating lamp. Intense infrared and ultraviolet radiation generated by the lamp can cause skin burns and severe eye damage.



CAUTION

- High temperature in the lamp is achieved during operation. Do not touch the lamp during operation and for at least 10 minutes after turning off.
- Do not operate the lamp near flammable gas or chemicals.
- Attach heat sinks on both bases and apply forced air cooling. Apply a sufficient amount of heat conductive grease on both bases to obtain proper thermal management conditions.
- Lamp must be fixed at the anode base only, leaving the cathode base free so as to reduce mechanical and thermal stress which could cause catastrophic failure. Read and follow all equipment instructions.
- The filling tip on the anode base of a used lamp should be removed in order to reduce the internal pressure of the lamp before disposal.

IMPORTANT OPERATION NOTES

- Correct polarity and burning position are critical for lamp operation and maintenance.
- Lamp must be operated less than rated current.
- The glass window of the lamp should be free from dust and not touched by bare fingers or hand. In order to remove grease stains or dust, use a lint free alcohol wipe.
- Replace the lamp at end of life, when blackening occurs or when lamp flicker becomes severe.
- Remove the vinyl tube on the filling tip before installation.



NOTICE

Equipment shown in this catalog and any products using the equipment or technologies relating to the equipment fall under the category of security control relating to freight or technologies under the provisions of the Foreign Exchange and Foreign Trade Control Law. Permission needs to be obtained.

