



HPS "Tall" Wallpack. Vandal resistant polycarbonate housing. Heavy die-cast aluminum back plate with 1/2" bottom and back conduit knockout. Factory installed 120V photocell with bypass cap included. Glare shield included. Lamp supplied.

Color: Bronze

Weight: 6.2 lbs

Project:	Type:
Prepared By:	Date:

Lamp Info		Ballast Info	
Type:	ED17	Type:	R-NPF 120V
Watts:	70W	120V:	2.1/1.6A
Shape/Size:	N/A	208V:	N/A
Base:	N/A	240V:	N/A
ANSI:	N/A	277V:	N/A
Hours:	24,000	Input Watts:	86W
Lamp Lumens:	6,300	Efficiency:	81%
Efficacy:	73 LPW		

Technical Specifications

Listings

cUL Listing:

Suitable for wet locations.

Construction

Reflector:

Die formed aluminum for wide light distribution. Moveable Glare Shield for field adjustable light control slanted slightly downward for more light on the job.

Housing and Refractor:

Vandal resistant polycarbonate molded refractor. Die cast aluminum back plate.

Electrical

Ballast Housing:

Stamped steel painted white.

Other

Back Plate:

Heavy die cast aluminum. 1/2" bottom conduit knockout. Knockouts for mounting to 3" or 4" junction boxes.

Patents:

The unique RC Tallpack is protected by Canada Patent D121,993, U.S. Patent D569,029; China Patent ZL200730149211.2; Taiwan Patent D124,864.

Optical

BUG Rating:

B1 U4 G4

Dimensions

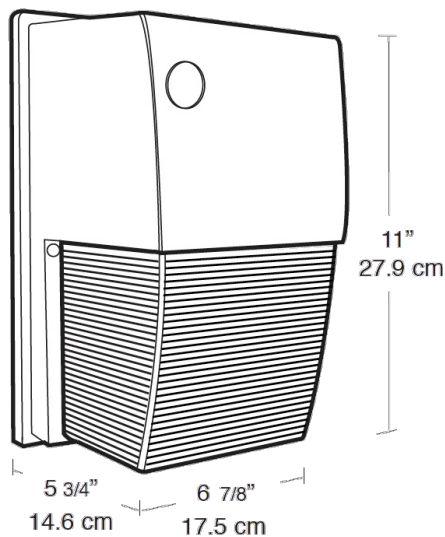

Features

- Heavy, die cast aluminum back plate with box mounting template
- Shades work great with tallpacks!
- 1/2" bottom conduit knockout
- Packaging has product features, ballast and lamp specifications
- Lighting layout photometrics and installation instructions are available