



Ultra high output, high efficiency 50 Watt LED wallpacks. Patent Pending airflow technology ensures long LED and driver lifespan. 5 Year Warranty.

Color: White

Weight: 34.8 lbs

Project:

Type:

Prepared By:

Date:

Driver Info

Type:	Constant Current
120V:	0.46A
208V:	0.27A
240V:	0.23A
277V:	0.20A
Input Watts:	52W
Efficiency:	97%

LED Info

Watts:	50W
Color Temp:	4000K
Color Accuracy:	82 CRI
L70 Lifespan:	100000
Lumens:	4,386
Efficacy:	85 LPW

Technical Specifications

Other

WPLED2T50 with Bi-Level Operation:

Allows 50% and 100% output modes.

Equivalency:

WPLED™ 50W replaces 200W metal halide

California Title 24:

WPLED50 with available photocell option complies with 2013 California Title 24 building and electrical codes as a commercial outdoor pole-mounted fixture ≤ 75 Watts. Add /PCT to include a photocell.

Patents:

The WPLED™ design is protected by patents pending in the U.S., Canada, China, Taiwan and Mexico.

Warranty:

RAB warrants that our LED products will be free from defects in materials and workmanship for a period of five (5) years from the date of delivery to the end user, including coverage of light output, color stability, driver performance and fixture finish.

Country of Origin:

Designed by RAB in New Jersey and assembled in the USA by RAB's IBEW Local 3 workers.

Buy American Act Compliant:

This product is a COTS item manufactured in the United States, and is compliant with the Buy American Act.

Recovery Act (ARRA) Compliant:

This product complies with the 52.225-21 "Required Use of American Iron, Steel, and Manufactured Goods-- Buy American Act-- Construction Materials (October 2010).

Trade Agreements Act Compliant:

This product is a COTS item manufactured in the United States, and is compliant with the Trade Agreements Act.

GSA Schedule:

Suitable in accordance with FAR Subpart 25.4.

Listings

UL Listing:

Suitable for wet locations as a downlight.

IESNA LM-79 & IESNA LM-80 Testing:

RAB LED fixtures have been tested by an independent laboratory in accordance with IESNA LM-79 and 80, and have received the Department of Energy "Lighting Facts" label.

Dark Sky Approved:

The International Dark Sky Association has approved this product as a full cutoff, fully shielded luminaire.

LED Characteristics

Lifespan:

100,000-hour LED lifespan based on IES LM-80 results and TM-21 calculations.

LEDs:

Multi-chip, high-output, long-life LEDs

Color Consistency:

3-step MacAdam Ellipse binning to achieve consistent fixture-to-fixture color.

Color Stability:

LED color temperature is warranted to shift no more than 200K in CCT over a 5 year period.

Color Uniformity:

RAB's range of CCT (Correlated Color Temperature) follows the guidelines of the American National Standard for Specifications for the Chromaticity of Solid State Lighting (SSL) Products, ANSI C78.377-2011.

Construction

IES Classification:

The Type II distribution is ideal for wide walkways, on ramps and entrance roadways, bike paths and other long and narrow lighting applications. This type is meant for lighting larger areas and usually is located near the roadside. This type of lighting is commonly found on smaller side streets or jogging paths.

IP Rating:

Ingress Protection rating of IP66 for dust and water.

Ambient Temperature:

Suitable for use in 40°C ambient temperatures.

Cold Weather Starting:

The minimum starting temperature is -40°C/-40°F

Thermal Management:

Superior patent pending thermal management design with external Air-Flow fins provides maximum operational life, even in high ambient temperature environments.

Housing:

Die cast aluminum housing, lens frame and mounting arm.

Mounting:

Heavy-duty mounting arm with "O" ring seal & stainless steel screws.

Reflector:

Specular vacuum-metallized polycarbonate

Technical Specifications (continued)

Construction

Gaskets:

High temperature silicone gaskets

Finish:

Our environmentally friendly polyester powder coatings are formulated for high-durability and long-lasting color, and contains no VOC or toxic heavy metals.

Green Technology:

Mercury and UV free. RoHS compliant components. Polyester powder coat finish formulated without the use of VOC or toxic heavy metals.

Electrical

Driver:

Constant Current, Class 2, 1400mA, 100-277V, 50-60Hz, 0.8A, Power Factor 99%

THD:

7.0% at 120V, 7.8% at 277V

Surge Protection:

6kV surge suppression protection tested in accordance with IEEE/ANSI C62.41.2.

Optical

BUG Rating:

B1 U0 G1

Dimensions

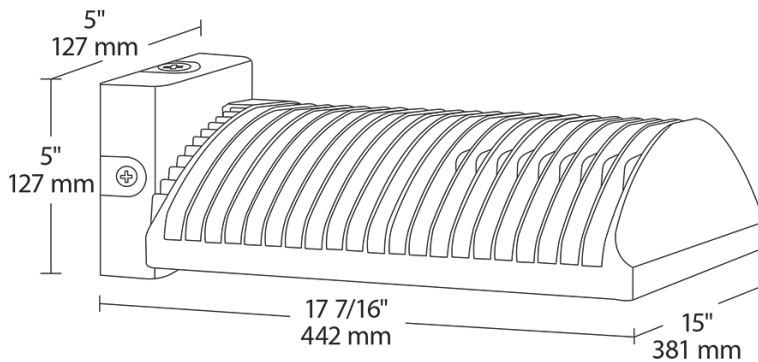

Features

High output, high efficiency LED

Maintains 70% of initial lumens at 100,000 hours

Weatherproof high temperature silicone gaskets

Superior heat sinking with die cast aluminum housing and external fins

100 up to 277 Volts

5-year warranty

Ordering Matrix

Family	Distribution	Watts	Color Temp	Mount	Finish	Voltage	Photocell	Dimming	Sensor	Bi-Level
WPLED										
	2T = Type II 3T = Type III 4T = Type IV	50 = 50W	Blank = 5000K (Cool) Y = 3000K (Warm) N = 4000K (Neutral)	Blank = Standard FX = Flat Wall	Blank = Bronze W = White	Blank = 120-277V /480 = 480V	Blank = No Photocell /PC = 120V Button /PC2 = 277 Button /PCS = 120V Swivel /PCS2 = 277V Swivel /PCT = 120-277V Twistlock /PCS4 = 480V Swivel /PCT4 = 480V Twistlock	Blank = No Dimming /D10 = Dimmable	/WS2 = Multi-Level Motion Sensor (Only available for 120-277V with /D10 for 50W)	Blank = No Bi-Level /BL = Bi-Level