



Ultra high output, high efficiency 260 Watt LED wallpacks. Patent Pending airflow technology ensures long LED and driver lifespan. 5 Year Warranty.

Color: Bronze

Weight: 79.4 lbs

Project:

Type:

Prepared By:

Date:

Driver Info

Type:	Constant Current
120V:	2.2A
208V:	1.3A
240V:	1.1A
277V:	1.0A
Input Watts:	265W
Efficiency:	98%

LED Info

Watts:	260W
Color Temp:	4000K
Color Accuracy:	71 CRI
L70 Lifespan:	100000
Lumens:	27,692
Efficacy:	105 LPW

Technical Specifications

Listings

UL Listing:

Suitable for wet locations.

DLC Listed:

This product is on the Design Lights Consortium (DLC) Qualified Products List and is eligible for rebates from DLC Member Utilities.

IESNA LM-79 & IESNA LM-80 Testing:

RAB LED luminaires have been tested by an independent laboratory in accordance with IESNA LM-79 and 80, and have received the Department of Energy "Lighting Facts" label.

Dark Sky Approved:

The International Dark Sky Association has approved this product as a full cutoff, fully shielded luminaire.

Construction

IP Rating:

Ingress Protection rating of IP66 for dust and water.

IES Classification:

The Type II distribution is ideal for wide walkways, on ramps and entrance roadways, bike paths and other long and narrow lighting applications. This type is meant for lighting larger areas and usually is located near the roadside. This type of lighting is commonly found on smaller side streets or jogging paths.

Maximum Ambient Temperature:

Suitable for use in 40°C (104°F) ambient temperatures

Cold Weather Starting:

The minimum starting temperature is -40°C/-40°F

Thermal Management:

Superior heat sinking with external Air-Flow fins.

Housing:

Die cast aluminum with airflow fins for cooling.

Lens:

Tempered glass

Reflector:

Vacuum-metalized polycarbonate

Gaskets:

High temperature silicone gaskets.

Finish:

Our environmentally friendly polyester powder coatings are formulated for high-durability and long-lasting color, and contains no VOC or toxic heavy metals.

Green Technology:

Mercury and UV free. RoHS compliant components. Polyester powder coat finish formulated without the use of VOC or toxic heavy metals.

For use on LEED Buildings:

IDA Dark Sky Approval means that this fixture can be used to achieve LEED Credits for Light Pollution Reduction.

LED Characteristics

LEDs:

Multi-chip, high-output, long-life LEDs

Color Consistency:

3-step MacAdam Ellipse binning to achieve consistent fixture-to-fixture color.

Color Stability:

LED color temperature is warranted to shift no more than 200K in CCT over a 5 year period.

Color Uniformity:

RAB's range of CCT (Correlated Color Temperature) follows the guidelines of the American National Standard for Specifications for the Chromaticity of Solid State Lighting (SSL) Products, ANSI C78.377-2011.

Electrical

Dimming Driver:

Driver includes dimming control wiring for 0-10V dimming systems. Requires separate 0-10V DC dimming circuit. Dims as low as 10%.

Drivers:

Constant Current, Class 1, 1660mA, 100-277V, 50-60Hz, 120V: 2.2A, 208V: 1.3A, 240V: 1.1A, 277V: 1.0A

Power Factor:

99.8% at 120V, 96.7% at 277V

Surge Protection:

6kV

Optical

THD:

4.7% at 120V, 7.2% at 277V

BUG Rating:

B3 U0 G4

Technical Specifications (continued)

Other

Country of Origin:

Designed by RAB in New Jersey and assembled in the USA by RAB's IBEW Local 3 workers.

Buy American Act Compliant:

This product is a COTS item manufactured in the United States, and is compliant with the Buy American Act.

Recovery Act (ARRA) Compliant:

This product complies with the 52.225-21 "Required Use of American Iron, Steel, and Manufactured Goods-- Buy American Act-- Construction Materials (October 2010).

Trade Agreements Act Compliant:

This product is a COTS item manufactured in the United States, and is compliant with the Trade Agreements Act.

GSA Schedule:

Suitable in accordance with FAR Subpart 25.4.

Warranty:

RAB warrants that our LED products will be free from defects in materials and workmanship for a period of five (5) years from the date of delivery to the end user, including coverage of light output, color stability, driver performance and fixture finish.

Patents:

The WPLED design is protected by patents pending in the U.S., Canada, China, Taiwan and Mexico.

Dimensions

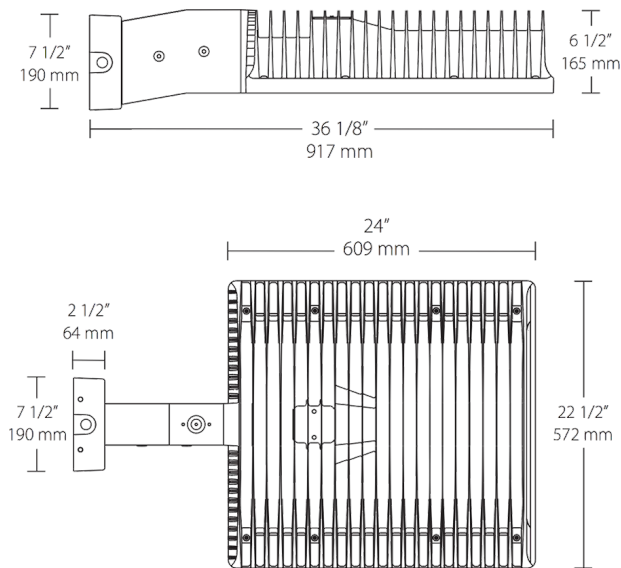

Features

- High output, high efficiency LED
- Maintains 70% of initial lumens at 100,000 hours
- Weatherproof high temperature silicone gaskets
- Superior heat sinking with die cast aluminum housing and external fins
- 5-year warranty