



Ultra high output, high efficiency 105 Watt LED wallpacks. Patent Pending airflow technology ensures long LED and driver lifespan. 5 Year Warranty.

Color: White

Weight: 34.8 lbs

Project:

Type:

Prepared By:

Date:

Driver Info

Type: Constant Current
 120V: 0.89A
 208V: N/A
 240V: N/A
 277V: N/A
 Input Watts: 106W
 Efficiency: 99%

LED Info

Watts: 105W
 Color Temp: 3000K
 Color Accuracy: 82 CRI
 L70 Lifespan: 100000
 Lumens: 8,299
 Efficacy: 78 LPW

Technical Specifications

Electrical

Photocell:

120V Swivel Photocell Included. Photocell is only compatible with 120V.

Drivers:

Two Drivers, Constant Current, Class 2, 1400mA, 100-277V, 50/60Hz, 0.8A, Power Factor 99%

THD:

7.6% at 120V, 16.2% at 277V

Listings

UL Listing:

Suitable for wet locations.

IESNA LM-79 & LM-80 Testing:

RAB LED luminaires have been tested by an independent laboratory in accordance with IESNA LM-79 and LM-80, and have been received the Department of Energy "Lighting Facts" label.

Dark Sky Approved:

The International Dark Sky Association has approved this product as a full cutoff, fully shielded luminaire.

DLC Listed:

This product is on the Design Lights Consortium (DLC) Qualified Products List and is eligible for rebates from DLC Member Utilities.
 DLC Product Code: P00001798

LED Characteristics

Lifespan:

100,000-hour LED lifespan based on IES LM-80 results and TM-21 calculations.

LEDs:

Multi-chip, high-output, long-life LEDs

Color Consistency:

3-step MacAdam Ellipse binning to achieve consistent fixture-to-fixture color.

Color Stability:

LED color temperature is warranted to shift no more than 200K in CCT over a 5 year period.

Color Uniformity:

RAB's range of CCT (Correlated Color Temperature) follows the guidelines of the American National Standard for Specifications for the Chromaticity of Solid State Lighting (SSL) Products, ANSI C78.377-2011.

Construction

IES Classification:

The Type II distribution is ideal for wide walkways, on ramps and entrance roadways, bike paths and other long and narrow lighting applications. This type is meant for lighting larger areas and usually is located near the roadside. This type of lighting is commonly found on smaller side streets or jogging paths.

IP Rating:

Ingress Protection rating of IP66 for dust and water.

Maximum Ambient Temperature:

Suitable for use in 40°C (104°F) ambient temperatures

Cold Weather Starting:

The minimum starting temperature is -40°C/-40°F

Thermal Management:

Superior thermal management with external Air-Flow fins.

Housing:

Die-cast aluminum housing, lens frame and mounting arm

Mounting:

Heavy-duty mounting arm with "O" ring seal & stainless steel screws

Reflector:

Specular vacuum-metallized polycarbonate

Gaskets:

High-temperature silicone gaskets

Finish:

Our environmentally friendly polyester powder coatings are formulated for high-durability and long-lasting color, and contains no VOC or toxic heavy metals.

Green Technology:

Mercury and UV free. RoHS compliant components. Polyester powder coat finish formulated without the use of VOC or toxic heavy metals.

For use on LEED Buildings:

IDA Dark Sky Approval means that this fixture can be used to achieve LEED Credits for Light Pollution Reduction.

Other

California Title 24:

WPLED2T105/PCS complies with 2013 California Title 24 building and electrical codes as a commercial outdoor pole-mounted fixture > 30 Watts mounted at height greater than 24 feet. For mounting heights < 24 feet see WPLED2T105/BL with bi-level operation; additional component requirements will be listed in the Title 24 section under technical specifications on the product page.

Warranty:

RAB warrants that our LED products will be free from defects in materials and workmanship for a period of five (5) years from the date of delivery to the end user, including coverage of light output, color stability, driver performance and fixture finish.

Technical Specifications (continued)

Other

Patents:

The design of WPLED105 is protected by patents pending in US, Canada, China, Taiwan and Mexico.

Country of Origin:

Designed by RAB in New Jersey and assembled in the USA by RAB's IBEW Local 3 workers.

Buy American Act Compliant:

This product is a COTS item manufactured in the United States, and is compliant with the Buy American Act.

Recovery Act (ARRA) Compliant:

This product complies with the 52.225-21 "Required Use of American Iron, Steel, and Manufactured Goods-- Buy American Act-- Construction Materials (October 2010).

Trade Agreements Act Compliant:

This product is a COTS item manufactured in the United States, and is compliant with the Trade Agreements Act.

GSA Schedule:

Suitable in accordance with FAR Subpart 25.4.

Optical

BUG Rating:

B1 U0 G2

Dimensions

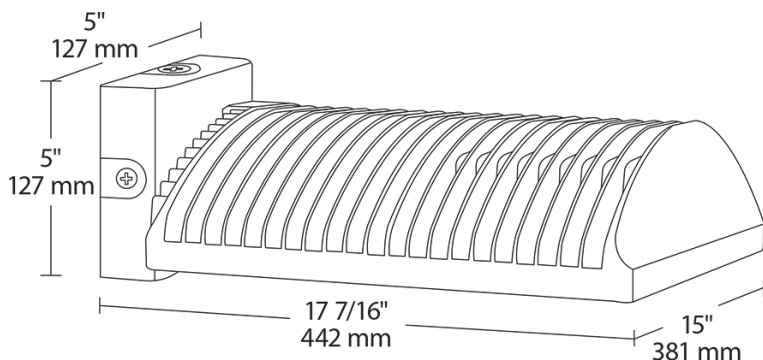

Features

- High output, high efficiency LED
- Maintains 70% of initial lumens at 100,000 hours
- Weatherproof high temperature silicone gaskets
- Superior heat sinking with die cast aluminum housing and external fins
- 100 up to 277 Volts
- 5-year warranty

Ordering Matrix

Family	Distribution	Watts	Color Temp	Mount	Finish	Voltage	Photocell	Dimming	Sensor	Bi-Level
WPLED										
	2T = Type II	105 =	Blank =	Blank =	Blank =	Blank =	Blank =	Blank =	/WS2 =	Blank =
	3T = Type III	105W	5000K	Standard	Bronze	120-277V	No	No	Multi-Level Motion Sensor (Only	No
	4T = Type IV		(Cool)	FX = Flat	W =	/480 =	/PC =	/D10 =	available for 120-277V with /D10 for 105W)	Bi-Level
			Y = 3000K	Wall	White	480V	120V	Dimmable		Level
			(Warm)				Button			
			N = 4000K				/PC2 =			
			(Neutral)				277			
							Button			
							/PCS =			
							120V			
							Swivel			
							/PCS2 =			
							277V			
							Swivel			
							/PCT =			
							120-			
							277V			
							Twistlock			
							/PCS4 =			
							480V			
							Swivel			
							/PCT4 =			
							480V			
							Twistlock			