



Fully shielded. Full Cutoff Wallpack. Full Cutoff optics for 400 Watt HPS or 320 - 400 Watt MH. Full Cutoff optics with flat tempered glass lens. Cap/ignitor cradle and EZ mount knock-outs for easy wiring. Lamp supplied.

Color: Bronze

Weight: 32.5 lbs

Project:	Type:
Prepared By:	Date:

Lamp Info		Ballast Info	
Type:	-	Type:	N/A
Watts:	400W	120V:	N/A
Shape/Size:	N/A	208V:	N/A
Base:	N/A	240V:	N/A
ANSI:	N/A	277V:	N/A
Hours:	N/A	Input Watts:	0W
Lamp Lumens:	N/A		
Efficacy:	N/A		

Technical Specifications

Listings

UL Listing:

Suitable for wet locations. HID fixtures can be wired with 90°C supply wiring if supply wires are routed 3" away from the ballast.

Dark Sky Approved:

The International Dark Sky Association has approved this product as a full cutoff, fully shielded luminaire.

Electrical

Photocell:

Swivel 120V Photocell Included. Photocell is only compatible with 120V.

Construction

Housing:

Die cast aluminum 1/2" NPS tapped holes top, both sides and back for conduit or photocontrol. Hinged refractor frame, Continuous silicone rubber gasket.

Reflector:

Specular anodized aluminum, removable for installation. Symmetrical light pattern maximizes distance between fixtures.

Finish:

Our environmentally friendly polyester powder coatings are formulated for high-durability and long-lasting color, and contains no VOC or toxic heavy metals.

For use on LEED Buildings:

IDA Dark Sky Approval means that this fixture can be used to achieve LEED Credits for Light Pollution Reduction.

Optical

Refractor:

Prismatic optics designed to minimize glare and throw light down and out. Heat resistant borosilicate glass.

Other

Buy American Act Compliant:

This product is a COTS item manufactured in the United States, and is compliant with the Buy American Act.

Recovery Act (ARRA) Compliant:

This product complies with the 52.225-21 "Required Use of American Iron, Steel, and Manufactured Goods-- Buy American Act-- Construction Materials (October 2010).

Trade Agreements Act Compliant:

This product is a COTS item manufactured in the United States, and is compliant with the Trade Agreements Act.

GSA Schedule:

Suitable in accordance with FAR Subpart 25.4.

Dimensions

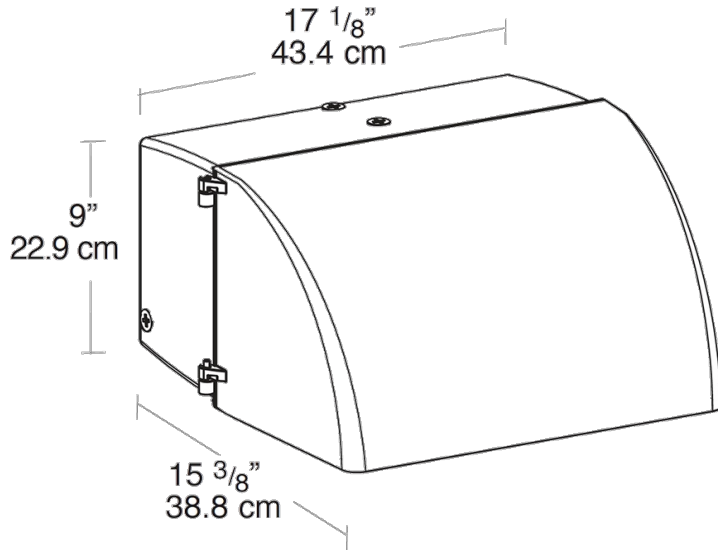

Features

- Hinged door frame opens and remains captive for easy relamping
- Precision die cast aluminum housing with durable polyester powder coating
- Silicone gasket remains in place during relamping
- Tempered glass refractor
- Long life lamp included