



Mid sized wallpack with emergency battery Backup and cutoff glare shield.

Color: White

Weight: 12.3 lbs

<b>Project:</b>	<b>Type:</b>
<b>Prepared By:</b>	<b>Date:</b>

Lamp Info		Ballast Info	
Type:	42W Triple	Type:	Elec HPF QT
Watts:	42W	120V:	0.38A
Shape/Size:	N/A	208V:	N/A
Base:	N/A	240V:	N/A
ANSI:	N/A	277V:	N/A
Hours:	10,000	Input Watts:	46W
Lamp Lumens:	3,200	Efficiency:	91%
Efficacy:	70 LPW		

**Technical Specifications**

**Electrical**

**Emergency Battery Backup:**

Bodine "Coldpak" will operate the CFL lamp for 90 minutes if power fails. Rated -20°C to 55°C. Battery is a maintenance free NiCad with 7 - 10 year life. Wired for 120V.

**Photocell:**

120V Button Photocell Included. Photocell is only compatible with 120V.

**Listings**

**UL Listing:**

Suitable for wet locations. HID fixtures can be wired with 90°C supply wiring if supply wires are routed 3" away from ballast.

**Construction**

**Housing:**

Die cast aluminum, 1/2" NPS tapped holes top, both sides and back for conduit or photocontrol. Hinged refractor frame. Continuous silicone rubber gasket.

**Reflector:**

Specular anodized aluminum, removable for installation. Symmetrical light pattern maximizes distance between fixtures.

**Cutoff Lens:**

Tempered glass.

**Finish:**

Our environmentally friendly polyester powder coatings are formulated for high-durability and long-lasting color, and contains no VOC or toxic heavy metals.

**Optical**

**Refractor:**

Prismatic optics designed to minimize glare and throw light down and out. Heat resistant borosilicate glass.

**Other**

**Country of Origin:**

Designed by RAB in New Jersey and assembled in the USA by RAB's IBEW Local 3 workers.

**Buy American Act Compliant:**

This product is a COTS item manufactured in the United States, and is compliant with the Buy American Act.

**Recovery Act (ARRA) Compliant:**

This product complies with the 52.225-21 "Required Use of American Iron, Steel, and Manufactured Goods-- Buy American Act-- Construction Materials (October 2010).

**Trade Agreements Act Compliant:**

This product is a COTS item manufactured in the United States, and is compliant with the Trade Agreements Act.

**GSA Schedule:**

Suitable in accordance with FAR Subpart 25.4.

## Dimensions

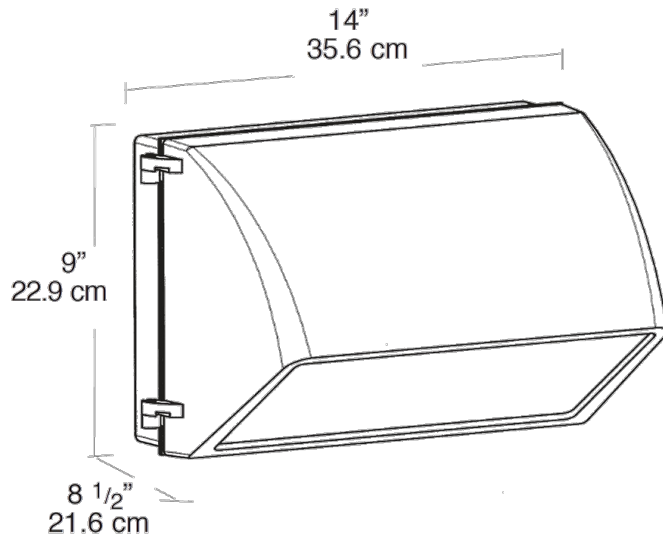

## Features

- Emergency battery backup meets NEC requirement
- Test button for required maintenance checks
- Indicator light illuminates when charging
- Maintenance free NiCad battery has 7-10 year life
- Silicone gasket remains in place during relamping
- Top, side and back conduit openings
- Long life lamp included