



Mid sized wallpack with emergency battery Backup and cutoff glare shield.

Color: Bronze

Weight: 12.3 lbs

Project:	Type:
Prepared By:	Date:

Lamp Info		Ballast Info	
Type:	42W Triple	Type:	Elec HPF QT
Watts:	42W	120V:	0.38A
Shape/Size:	N/A	208V:	N/A
Base:	N/A	240V:	N/A
ANSI:	N/A	277V:	N/A
Hours:	10,000	Input Watts:	46W
Lamp Lumens:	3,200	Efficiency:	91%
Efficacy:	70 LPW		

Technical Specifications

Electrical

Emergency Battery Backup:

Bodine "Coldpak" will operate the CFL lamp for 90 minutes if power fails. Rated -20°C to 55°C. Battery is a maintenance free NiCad with 7 - 10 year life. Wired for 120V.

Photocell:

120V Button Photocell Included. Photocell is only compatible with 120V.

Listings

UL Listing:

Suitable for wet locations. HID fixtures can be wired with 90°C supply wiring if supply wires are routed 3" away from ballast.

Construction

Housing:

Die cast aluminum, 1/2" NPS tapped holes top, both sides and back for conduit or photocontrol. Hinged refractor frame. Continuous silicone rubber gasket.

Reflector:

Specular anodized aluminum, removable for installation. Symmetrical light pattern maximizes distance between fixtures.

Cutoff Lens:

Tempered glass.

Finish:

Our environmentally friendly polyester powder coatings are formulated for high-durability and long-lasting color, and contains no VOC or toxic heavy metals.

Optical

Refractor:

Prismatic optics designed to minimize glare and throw light down and out. Heat resistant borosilicate glass.

Other

Country of Origin:

Designed by RAB in New Jersey and assembled in the USA by RAB's IBEW Local 3 workers.

Buy American Act Compliant:

This product is a COTS item manufactured in the United States, and is compliant with the Buy American Act.

Recovery Act (ARRA) Compliant:

This product complies with the 52.225-21 "Required Use of American Iron, Steel, and Manufactured Goods-- Buy American Act-- Construction Materials (October 2010).

Trade Agreements Act Compliant:

This product is a COTS item manufactured in the United States, and is compliant with the Trade Agreements Act.

GSA Schedule:

Suitable in accordance with FAR Subpart 25.4.

Dimensions

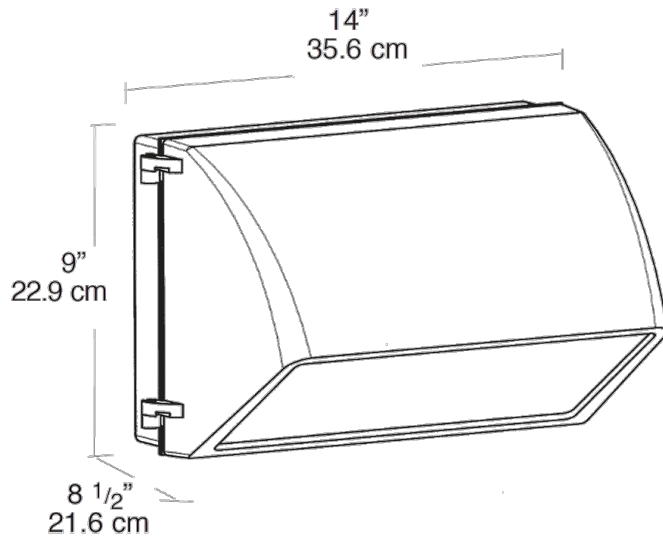

Features

- Emergency battery backup meets NEC requirement
- Test button for required maintenance checks
- Indicator light illuminates when charging
- Maintenance free NiCad battery has 7-10 year life
- Silicone gasket remains in place during relamping
- Top, side and back conduit openings
- Long life lamp included