



The same Wallpack as the WP1, but with prismatic glass lens to eliminate yellowing. Lamp supplied.

Color: White

Weight: 7.2 lbs

Project:	Type:
Prepared By:	Date:

Lamp Info		Ballast Info	
Type:	ED17	Type:	R-NPF 120V
Watts:	35W	120V:	1.4/0.9A
Shape/Size:	N/A	208V:	N/A
Base:	N/A	240V:	N/A
ANSI:	N/A	277V:	N/A
Hours:	24,000	Input Watts:	46W
Lamp Lumens:	2,250	Efficiency:	76%
Efficacy:	49 LPW		

Technical Specifications

Listings

UL Listing:

Suitable for wet locations. HID fixtures can be wired with 90°C supply wiring if supply wires are routed 3" away from the ballast.

Construction

Housing:

Die cast aluminum, 1/2" NPS tapped top, both sides and back for conduit or photocontrol. Hinged refractor. Continuous one piece silicone rubber gasket.

Reflector:

Semi-Specular anodized aluminum, removable for installation. Symmetrical light pattern maximizes distance between fixtures.

Finish:

Our environmentally friendly polyester powder coatings are formulated for high-durability and long-lasting color, and contains no VOC or toxic heavy metals.

Conduit Openings:

Top, side and back.

Template:

Drilling template for easy wall box mounting.

Other

Patents:

Pat. D440,683.

Country of Origin:

Designed by RAB in New Jersey and assembled in the USA by RAB's IBEW Local 3 workers.

Buy American Act Compliant:

This product is a COTS item manufactured in the United States, and is compliant with the Buy American Act.

Recovery Act (ARRA) Compliant:

This product complies with the 52.225-21 "Required Use of American Iron, Steel, and Manufactured Goods-- Buy American Act-- Construction Materials (October 2010).

Trade Agreements Act Compliant:

This product is a COTS item manufactured in the United States, and is compliant with the Trade Agreements Act.

GSA Schedule:

Suitable in accordance with FAR Subpart 25.4.

Dimensions

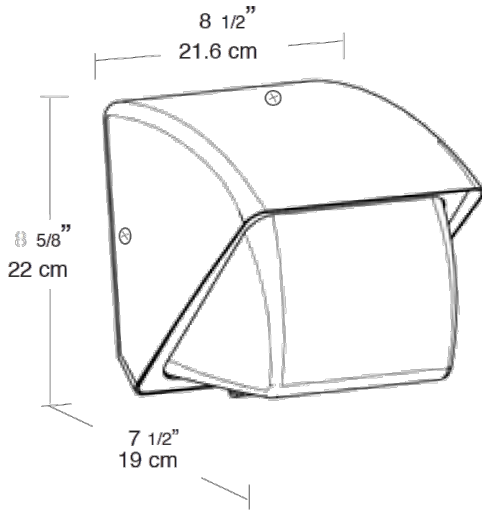

Features

- Precision die cast aluminum housing with durable polyester powder coating
- Easy access conduit openings & ballasts for fast internal wiring
- Long life lamp included
- Silicone gasket remains in place during relamping
- Cutoff glare shield for "friendly" lighting
- Hinged door swings open and remains captive for easy relamping