



High performance, wall mount LED Vaporproof fixture. A classic design with cutting edge LED technology. Comes with die cast guard and frosted globe.

Color: Natural

Weight: 5.0 lbs

Project:	Type:
Prepared By:	Date:

Driver Info		LED Info	
Type:	Constant Current	Watts:	13W
120V:	0.13A	Color Temp:	3000K
208V:	N/A	Color Accuracy:	86 CRI
240V:	N/A	L70 Lifespan:	100000
277V:	N/A	Lumens:	507
Input Watts:	15W	Efficacy:	33 LPW
Efficiency:	85%		

Technical Specifications

LED Characteristics

Lifespan:

100,000-hour LED lifespan based on IES LM-80 results and TM-21 calculations.

Color Consistency:

3-step MacAdam Ellipse binning to achieve consistent fixture-to-fixture color.

Color Stability:

LED color temperature is warranted to shift no more than 200K in CCT over a 5 year period.

Color Uniformity:

RAB's range of CCT (Correlated Color Temperature) follows the guidelines of the American National Standard for Specifications for the Chromaticity of Solid State Lighting (SSL) Products, ANSI C78.377-2011.

Electrical

Photocell:

120V Swivel Photocell Included. Photocell is only compatible with 120V.

Driver:

Multi-chip single 13W high output long life LED Driver. Constant Current, 100V-277V, 50/60 Hz., 100-240VAC. 3-.15 Amps 277VAC. 15 Amps. Will deliver 70% of its initial lumens at 100,000 hours based on LM-80 Tests.

Surge Protection:

4kV

Construction

Globes and Guards:

Vaporproof LEDs are compatible with RAB Globes and Guards.

Construction:

Die cast aluminum housing and door. Tether connects back housing halves for safety.

Cold Weather Starting:

Minimum starting temperature is -40°F / -40°C.

Ambient Temperature:

Suitable for use in 35°C (95°F) ambient temperatures.

Housing:

Die cast aluminum housing and driver housing.

Mounting:

Three 1/2" NPS conduit entry points.

Guard and Globe:

Shot blasted guard with frosted globe.

Reflector:

High quality hydroformed semi-specular aluminum.

Gaskets:

High Temperature Silicone.

Finish:

Natural shot blasted aluminum.

Green Technology:

Mercury and UV free. RoHS compliant components. Polyester powder coat finish formulated without the use of VOC or toxic heavy metals.

Other

Thermal Management (Patent Pending):

Die cast aluminum LED housing designed for maximum heat dissipation.

Equivalency:

The VXBRLED13 is Equivalent in delivered lumens to a 60W Incandescent or 23W CFL.

HID Replacement Range:

The VXBRLED13 can be used to replace 13-23W CFL or 25-60W Incandescent Vaporproofs based on delivered lumens.

Warranty:

RAB warrants that our LED products will be free from defects in materials and workmanship for a period of five (5) years from the date of delivery to the end user, including coverage of light output, color stability, driver performance and fixture finish.

Patents:

The VXBRLED design is protected by Taiwan Patent 01510951 and patents pending in the U.S., Canada, China and Mexico.

Country of Origin:

Designed by RAB in New Jersey and assembled in Taiwan.

Trade Agreements Act Compliant:

This product is a product of Taiwan and a "designated country" end product that complies with the Trade Agreements Act.

GSA Schedule:

Suitable in accordance with FAR Subpart 25.4.

Technical Specifications (continued)

Other

Country of Origin:

Designed by RAB in New Jersey and assembled in the USA by RAB's IBEW Local 3 workers.

Buy American Act Compliant:

This product is a COTS item manufactured in the United States, and is compliant with the Buy American Act.

Recovery Act (ARRA) Compliant:

This product complies with the 52.225-21 "Required Use of American Iron, Steel, and Manufactured Goods-- Buy American Act-- Construction Materials (October 2010).

Trade Agreements Act Compliant:

This product is a COTS item manufactured in the United States, and is compliant with the Trade Agreements Act.

Listings

IESNA LM-79 & IESNA LM-80 Testing:

RAB LED luminaires have been tested by an independent laboratory in accordance with IESNA LM-79 and 80, and have received the Department of Energy "Lighting Facts" label.

UL Listing:

UL Listed Suitable for Wet locations as a Downlight.

Optical

BUG Rating:

B0 U2 G1

Dimensions

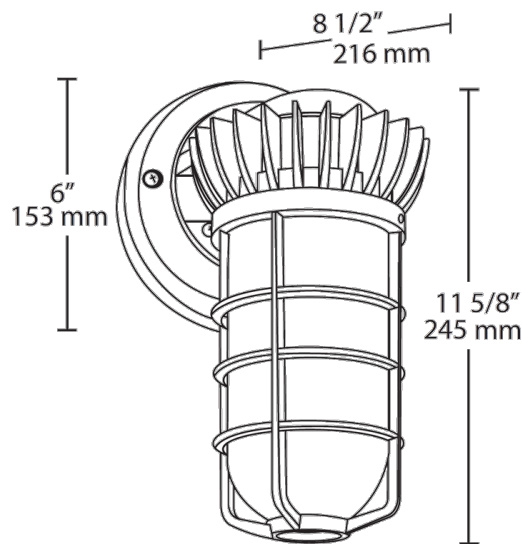

Features

- Vaporproof LED Wall Mount
- Superior Thermal Management (Patent Pending)
- All Die-Cast Aluminum Construction
- 100,000 hour life based on LM-80 tests
- Thermal Shock-Resistant Frosted Glass Globe
- Traditional Look, Cutting-Edge Technology
- 5-year LED warranty