



Low-profile vandal-resistant fixture covers the footprint of most traditional canopy lights. Available in flat or drop lens with frosted and unfrosted options.

Color: Bronze

Weight: 12.0 lbs

<b>Project:</b>	<b>Type:</b>
<b>Prepared By:</b>	<b>Date:</b>

Driver Info		LED Info	
Type:	Constant Current	Watts:	75W
120V:	N/A	Color Temp:	3000K
208V:	N/A	Color Accuracy:	74 CRI
240V:	N/A	L70 Lifespan:	100000
277V:	N/A	Lumens:	7622
Input Watts:	80W	Efficacy:	95 LPW
Efficiency:	93%		

## Technical Specifications

### Listings

#### UL Listing:

Suitable for wet locations.

#### IESNA LM-79 & LM-80 Testing:

RAB LED luminaires have been tested by an independent laboratory in accordance with IESNA LM-79 and LM-80, and have received the Department of Energy "Lighting Facts" label.

### Electrical

#### Drivers:

Class 2, Constant Current, 200-480V, 1980mA, 50-60Hz, <20% THD, >0.93pF, 0-10V Dimming to 10%

#### THD:

14.3% at 480V

#### Power Factor:

88.9% at 480V

#### Dimming Driver:

Driver includes dimming control wiring for 0-10V dimming systems. Requires separate 0-10V DC dimming circuit. Dims as low as 10%.

#### Photocell:

480V Swivel Photocell Included. Photocell is only compatible with 347-480V.

### Construction

#### Maximum Ambient Temperature:

Suitable for use in 104° F (40°C) ambient temperatures

#### Cold Weather Starting:

Minimum starting temperature is -40° F (-40° C)

#### Housing:

Die-cast aluminum housing and lens frame with (4) 1/2" NPS side conduit entries and weatherproof rear wire plug and access plate

#### Mounting:

Ceiling mount to recessed junction with knockout template or directly to ceiling surface, utilizing side conduit entry points.

#### IP Rating:

Ingress Protection rating of IP66 for dust and water

#### Lens:

Vandal-resistant polycarbonate textured opaque for low glare drop lens

#### Reflector:

Semi-specular, vacuum-metalized polycarbonate

#### Gaskets:

High-temperature silicone gaskets

#### Finish:

Our environmentally friendly polyester powder coatings are formulated for high-durability and long-lasting color, and contain no VOC or toxic heavy metals.

#### Green Technology:

Mercury and UV free. RoHS compliant components. Polyester powder coat finish formulated without the use of VOC or toxic heavy metals.

### LED Characteristics

#### LEDs:

Discreet LEDs on PCB board

#### Color Stability:

RAB LEDs exceed industry standards for chromatic stability.

#### Color Uniformity:

RAB's range of CCT (Correlated Color Temperature) follows the guidelines of the American National Standard for Specifications for the Chromaticity of Solid State Lighting (SSL) Products, ANSI C78.377-2015.

#### Replacement:

Replaces up to 200W Metal Halide.

#### Other

#### Warranty:

RAB warrants that our LED products will be free from defects in materials and workmanship for a period of five (5) years from the date of delivery to the end user, including coverage of light output, color stability, driver performance and fixture finish. See our full warranty

#### Country of Origin:

Designed by RAB in New Jersey and assembled in the USA by RAB's IBEW Local 3 workers.

#### Buy American Act Compliant:

This product is a COTS item manufactured in the United States, and is compliant with the Buy American Act.

#### Recovery Act (ARRA) Compliant:

This product complies with the 52.225-21 "Required Use of American Iron, Steel, and Manufactured Goods-- Buy American Act-- Construction Materials (October 2010).

#### Trade Agreements Act Compliant:

This product is a COTS item manufactured in the United States, and is compliant with the Trade Agreements Act.

## Technical Specifications (continued)

### Other

#### GSA Schedule:

Suitable in accordance with FAR Subpart 25.4.

### Dimensions

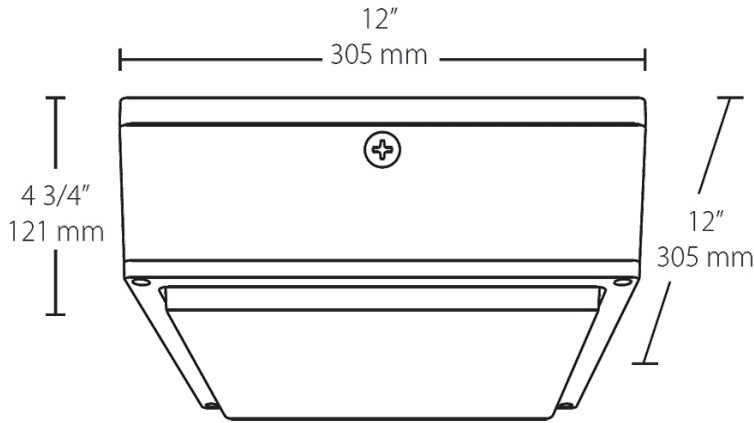

### Features

- Fits the footprint of older canopy lights
- Vandal resistant and UV resistant lens
- Ultra-high efficiency
- Clean, contemporary, low-profile design
- Available with drop lens or flat lens
- IP66 rated, keeps dust, bugs and water out
- Photo and motion sensor options available

### Ordering Matrix

Family	Watts	Color Temp	Lens	Motion Sensor & Finish	Driver Options	Photocell Options
D10						
	10 = 10W	Blank = 5000K (Cool)	Blank = Drop lens	Blank = Bronze, no sensor W = White, no sensor	Blank = On/Off driver /D10 = 0-10V Dimming (not available for 10w)	/PCS = 120V Swivel
	20 = 20W	N = 4000K (Neutral)	F = Flat lens FR = Frosted Drop Lens	MS = Bronze w/ SMS500 mini-sensor (not available w/ D10 models)	/480 = 480V (not available for 10W or 20W)	/PCS2 = 277V Swivel
	40 = 40W	Y = 3000K (Warm)	FFR = Frosted Flat Lens	MSW = White w/ SMS500 mini-sensor (not available w/ D10 models)	/480/D10 = 480V w/ 0-10V dimming (not available for 10W or 20W)	/PCS4 = 480V Swivel
	52 = 52W					
	65 = 65W					
	75 = 75W					