



Large size ceiling mount fixture: Horizontal CFL lamps. "No Bend" conduit entrance. Housing is die cast aluminum with clear vandalproof polycarbonate refractor. Available with Emergency Battery Backup option with 42 Watt. Lamp supplied

Color: N/A

Weight: 10.0 lbs

Project:	Type:
Prepared By:	Date:

Lamp Info		Ballast Info	
Type:	2-42W Triple	Type:	Elec HPF QT
Watts:	84W	120V:	0.78A
Shape/Size:	N/A	208V:	0.5A
Base:	N/A	240V:	0.5A
ANSI:	N/A	277V:	0.33A
Hours:	12,000	Input Watts:	93W
Lamp Lumens:	6,400	Efficiency:	90%
Efficacy:	69 LPW		

Technical Specifications

Listings

UL Listing:

Suitable for wet locations. Fixtures can be wired with 90°C supply wiring if supply wires are routed 3" away from ballast.

Electrical

Sockets:

Medium base 4kv Pulse Rated Glazed porcelain.

HID Quartz restrike:

Add suffix "/QR" to Van3 (50w restrike) or Van5 (100w restrike) for HOT restrike. Provides immediate illumination in case of momentary power failure.

Quad Tap:

Fixture works with 120, 208, 240 and 277 Volts.

Optical

Refractor:

Injection molded polycarbonate, designed for maximum structural strength.

Construction

Housings:

Die cast aluminum with powder coat bronze or white finish.

Screws:

Tamperproof center pin Torx-head and slotted Phillips head stainless steel screws provided. Be sure to order your Torx screwdriver (Catalog # VANDRIVER).

Reflectors / Backplate:

Heavy gauge cold rolled steel with high reflectance baked white enamel.

Ballast Minimum Starting Temperature:

0°F.

Other

Patents:

The unique RAB VAN5 is protected by U.S. Patent D547,484; China Patent ZL200630133218.0; Taiwan Patent D121,295 and Canada Patent D115,523.

Country of Origin:

Designed by RAB in New Jersey and assembled in the USA by RAB's IBEW Local 3 workers.

Buy American Act Compliant:

This product is a COTS item manufactured in the United States, and is compliant with the Buy American Act.

Recovery Act (ARRA) Compliant:

This product complies with the 52.225-21 "Required Use of American Iron, Steel, and Manufactured Goods-- Buy American Act-- Construction Materials (October 2010).

Trade Agreements Act Compliant:

This product is a COTS item manufactured in the United States, and is compliant with the Trade Agreements Act.

GSA Schedule:

Suitable in accordance with FAR Subpart 25.4.

Dimensions

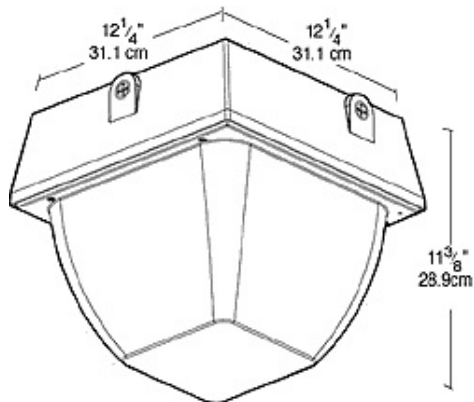

Features

- Vertical lamp for better light disbursement and heat dissipation
- Adjustable 4 way Glare Guard
- Increased Wattage to 200W MH PS
- Glare Stopper shield, Vandal proof Center Pin Torx and slotted Phillips head screws supplied
- Tough polycarbonate refractor with Die cast aluminum housing
- Electronic Fluorescent Ballast with 0°F Starting Temperature
- Improved Heat Control