

Project:	Type:
Prepared By:	Date:

Lamp Info		Ballast Info	
Type:	ED17	Type:	R-NPF 120V
Watts:	50W	120V:	1.8/1.2A
Shape/Size:	N/A	208V:	N/A
Base:	N/A	240V:	N/A
ANSI:	N/A	277V:	N/A
Hours:	24,000	Input Watts:	62W
Lamp Lumens:	4,000	Efficiency:	81%
Efficacy:	65 LPW		

Technical Specifications

Listings

UL Listing:

Suitable for wet locations. Fixtures can be wired with 90°C supply wiring if supply wires are routed 3" away from ballast.

Electrical

Sockets:

Medium base 4kv Pulse Rated Glazed porcelain.

HID Quartz restrike:

Add suffix "QR" to Van3 (50w restrike) or Van5 (100w restrike) for HOT restrike. Provides immediate illumination in case of momentary power failure.

Photocell:

Button Photocell 120V included. Photocell is only compatible with 120V.

Optical

Refractor:

Injection molded polycarbonate, designed for maximum structural strength.

Construction

Housings:

Die cast aluminum with powder coat bronze or white finish.

Screws:

Tamperproof center pin Torx-head and slotted Phillips head stainless steel screws provided. Be sure to order your Torx screwdriver (Catalog # VANDRIVER).

Reflectors / Backplate:

Heavy gauge cold rolled steel with high reflectance baked white enamel.

Conduit Entry:

1/2".

Other

Country of Origin:

Designed by RAB in New Jersey and assembled in the USA by RAB's IBEW Local 3 workers.

Buy American Act Compliant:

This product is a COTS item manufactured in the United States, and is compliant with the Buy American Act.

Recovery Act (ARRA) Compliant:

This product complies with the 52.225-21 "Required Use of American Iron, Steel, and Manufactured Goods-- Buy American Act-- Construction Materials (October 2010).

Trade Agreements Act Compliant:

This product is a COTS item manufactured in the United States, and is compliant with the Trade Agreements Act.

GSA Schedule:

Suitable in accordance with FAR Subpart 25.4.

Dimensions

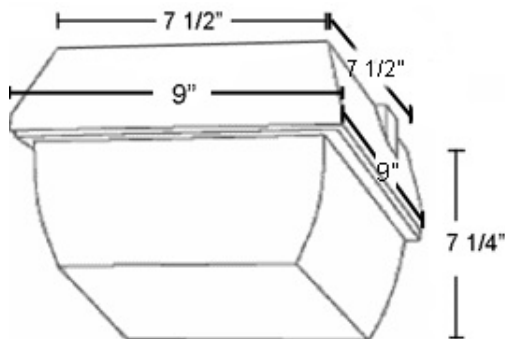

Features

- Both Vandal proof Center Pin Torx and slotted Phillips head screws supplied
- Tough polycarbonate refractors
- Die cast aluminum housing
- Quartz Restrike available, consult factory