



LED roadway lighting that replaces up to 250W MH or 150W HPS. Optics are factory installed and meet IES Distribution Type IV.

Color: Gray

Weight: 9.2 lbs

<b>Project:</b>	<b>Type:</b>
<b>Prepared By:</b>	<b>Date:</b>

Driver Info		LED Info	
Type:	Constant Current	Watts:	95W
120V:	0.78A	Color Temp:	4000K
208V:	0.46A	Color Accuracy:	72 CRI
240V:	0.40A	L70 Lifespan:	100000
277V:	0.34A	Lumens:	9,582
Input Watts:	94W	Efficacy:	102 LPW
Efficiency:	N/A		

## Technical Specifications

### Listings

#### UL Listing:

Suitable for wet locations. Minimum of 75° supply conductors.

#### IESNA LM-79 & IESNA LM-80 Testing:

RAB LED fixtures have been tested by an independent laboratory in accordance with IESNA LM-79 and 80, and have received the Department of Energy "Lighting Facts" label.

### Construction

#### IES Classification:

The Type IV distribution (also known as a Forward Throw) is especially suited for illuminating the perimeter of parking areas and for intersections. It produces a semicircular distribution with essentially the same candlepower at lateral angles from 90° to 270°.

#### IP Rating:

Ingress Protection rating of IP66 for dust and water

#### Vibration Rating:

Industry-leading 5G vibration rating per ANSI C136.31.

#### Ambient Temperature:

Suitable for use in 40°C ambient temperatures.

#### Cold Weather Starting:

The minimum starting temperature is -22° F (-30°C).

#### Thermal Management:

Superior thermal management design with external Air-Flow fins provides maximum operational life, even in high ambient temperature environments.

#### Housing:

Die cast aluminum housing with polycarbonate driver cover.

#### Lens:

Clear acrylic lens with integrated optics

#### Mounting:

Fits most standard roadway upsweep arms. Adaptor brackets supplied fit 1", 1 1/4", 1 1/2" and 2" pipe arms. Fixture can be tilted at the following angles -5°, -2.5°, 0°, +2.5°, +5°.

#### Gaskets:

High temperature silicone gaskets

#### Effective Projected Area:

EPA = 0.8

#### Finish:

Our environmentally friendly polyester powder coatings are formulated for high-durability and long-lasting color, and contains no VOC or toxic heavy metals.

#### Green Technology:

Mercury and UV free. RoHS compliant components. Polyester powder coat finish formulated without the use of VOC or toxic heavy metals.

### LED Characteristics

#### LEDs:

Multi-chip, high-output, long-life LEDs

#### Color Stability:

LED color temperature is warranted to shift no more than 200K in CCT over a 5 year period.

#### Color Uniformity:

RAB's range of CCT (Correlated Color Temperature) follows the guidelines of the American National Standard for Specifications for the Chromaticity of Solid State Lighting (SSL) Products, ANSI C78.377-2015.

### Electrical

#### Drivers:

Constant Current, Class 2, 120-277V, 50-60Hz, 120V: 0.27A, 208A: 0.17A, 240A: 0.15A, 277V: 0.13A

#### Dimming Driver:

Driver includes dimming control wiring for 0-10V dimming systems. Requires separate 0-10V DC dimming circuit. Dims as low as 10%.

#### 7-Pin Receptacle:

ANSI C136.41 7-pin receptacle, compatible with wireless control systems

#### Surge Protection:

10KV

### Optical

#### BUG Rating:

B1 U0 G1

### Other

#### Equivalency:

Replaces 250W Metal Halide or 150W HPS.

#### Photocell:

120-277V Twistlock Photocell Included. Photocell is compatible with 120V-277V.

#### Accessory:

Shorting Cap for 7-Pin Receptacle

## Technical Specifications (continued)

### Other

#### Warranty:

RAB warrants that our LED products will be free from defects in materials and workmanship for a period of ten (10) years from the date of delivery to the end user, including coverage of light output, color stability, driver performance and fixture finish.

#### Country of Origin:

Designed by RAB in New Jersey and assembled in the USA by RAB's IBEW Local 3 workers.

#### Buy American Act Compliant:

This product is a COTS item manufactured in the United States, and is compliant with the Buy American Act.

#### Recovery Act (ARRA) Compliant:

This product complies with the 52.225-21 "Required Use of American Iron, Steel, and Manufactured Goods-- Buy American Act-- Construction Materials (October 2010).

#### Trade Agreements Act Compliant:

This product is a COTS item manufactured in the United States, and is compliant with the Trade Agreements Act.

#### GSA Schedule:

Suitable in accordance with FAR Subpart 25.4.

## Dimensions

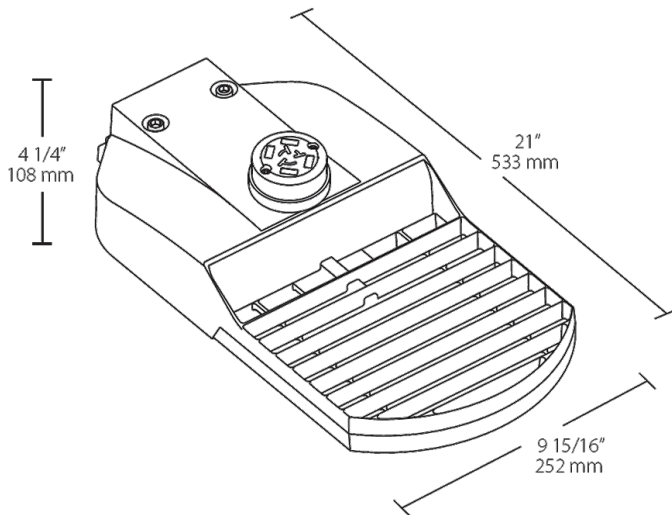

## Features

IP66 Rated

Industry-leading 5G vibration rating per ANSI C136.31

ANSI C136.41 7-pin receptacle, compatible with wireless control systems

100,000-Hour LED lifespan

10-Year limited warranty

## Ordering Matrix

Family	IES Type	Wattage	Color Temp	Color	Driver Options	Sensor Options
TBLED	4T	95	N	RG	/D10	/PCT
	4T = Type IV	95 = 95W 64 = 64W 48 = 48W 32 = 32W	Blank = 5000K (Cool) N = 4000K (Neutral) Y = 3000K (Warm) AY = 2000K (HPS Warm)	RG = Roadway Gray	/D10 = 0-10V Dimming (standard) /480/D10 = 480V 0-10V Dimming	/7PR = 7-Pin Receptacle (standard) /7PRS = 7-Pin Receptacle w/ Shorting Cap /PCT = 120-277V Twistlock Photocell w/ 7-Pin Receptacle /PCT4 = 480V Twistlock Photocell w/ 7-Pin Receptacle