



Clean, unobtrusive design delivers smooth and abundant light from an aperture just over 1 inch wide. Available in flush trim for a trimless look without the mess left behind from ceiling finishing work.

Color: Silver trim

Weight: 2.9 lbs

<b>Project:</b>	<b>Type:</b>
<b>Prepared By:</b>	<b>Date:</b>

Driver Info		LED Info	
Type:	Constant Current	Watts:	8W
120V:	0.08A	Color Temp:	4000K
208V:	N/A	Color Accuracy:	83 CRI
240V:	N/A	L70 Lifespan:	N/A
277V:	N/A	Lumens:	725
Input Watts:	8W	Efficacy:	87 LPW
Efficiency:	96%		

## Technical Specifications

### Listings

#### UL Listing:

Suitable for wet locations in a covered ceiling

#### ENERGY STAR:

This product is ENERGY STAR® qualified.

#### IESNA LM79 & LM-80 Testing:

RAB LED luminaries have been tested by an independent laboratory in accordance with IESNA LM-79 and LM-80, and have received the Department of Energy "Lighting Facts" label.

### Construction

#### IC Rating:

Suitable for direct contact with insulation

#### Trim Component:

This component can be ordered with New Construction housing in order to make a complete fixture.

#### Ambient Temperature:

Suitable for use in 55°C ambient temperatures

#### Cold Weather Starting:

The minimum starting temperature is -40°F/-40°C

#### Lens:

Nanostructure lens eliminates "hot spots", and helps provide smooth, uniform light and higher efficiency

#### Junction Box:

Integral junction box with wiring capacity for Min 60°C supply conductors  
End of Run

#### Housing:

Specification-grade, die-cast aluminum construction

#### Installation:

Torsion springs easily install into ceiling collar (remodeler) or rough-in (new construction)

#### Green Technology:

Mercury and UV free. RoHS compliant components. Polyester powder coat finish formulated without the use of VOC or toxic heavy metals.

#### Finish:

Our environmentally friendly polyester powder coatings are formulated for high-durability and long-lasting color, and contain no VOC or toxic heavy metals.

### LED Characteristics

#### LED:

High-output, long-life LED with 2-step binning and integrated driver technology

#### Color Consistency:

2-step MacAdam Ellipse binning to achieve consistent fixture-to-fixture color

#### Color Stability:

LED color temperature is warranted to shift no more than 200K in CCT over a 5 year period

### Electrical

#### Driver:

Constant Current, Class 2, 120VAC Only, 50/60Hz, 200mA, 0.07A

#### Dimming Driver:

TRIAC and ELV (at 120V only).

### Optical

#### Optics:

40° beam spread with specular thermoplastic optics

#### Spacing Criteria:

0-180° (along): 0.68  
90-270° (across): 0.68  
diagonal: 0.70

### Other

#### Trimless Look:

Flush trim for a trimless look without the hassle. Complete ceiling finishing work (spackling, sanding, painting) before installing to ensure a clean trim.

#### Equivalency:

RDLED 8W is equivalent to 50W MR16

#### California Title 24:

RDLED2R8 complies with 2013 California Title 24 building and electrical codes as a commercial indoor fixture for general spaces when used with a vacancy sensor and TRIAC dimming control. Select a vacancy sensor using catalog number LVS800. TRIAC dimmer provided by others.

#### Warranty:

RAB warrants that our LED products will be free from defects in materials and workmanship for a period of ten (10) years from the date of delivery to the end user, including coverage of light output, color stability, driver performance and fixture finish.

#### Country of Origin:

Designed by RAB in New Jersey and assembled in the USA by RAB's IBEW Local 3 workers.

#### Buy American Act Compliant:

This product is a COTS item manufactured in the United States, and is compliant with the Buy American Act.

## Technical Specifications (continued)

### Other

#### Recovery Act (ARRA) Compliant:

This product complies with the 52.225-21 "Required Use of American Iron, Steel, and Manufactured Goods-- Buy American Act-- Construction Materials (October 2010)

#### Trade Agreements Act Compliant:

This product is a COTS item manufactured in the United States, and is compliant with the Trade Agreements Act.

#### GSA Schedule:

Suitable in accordance with FAR Subpart 25.4

### Dimensions

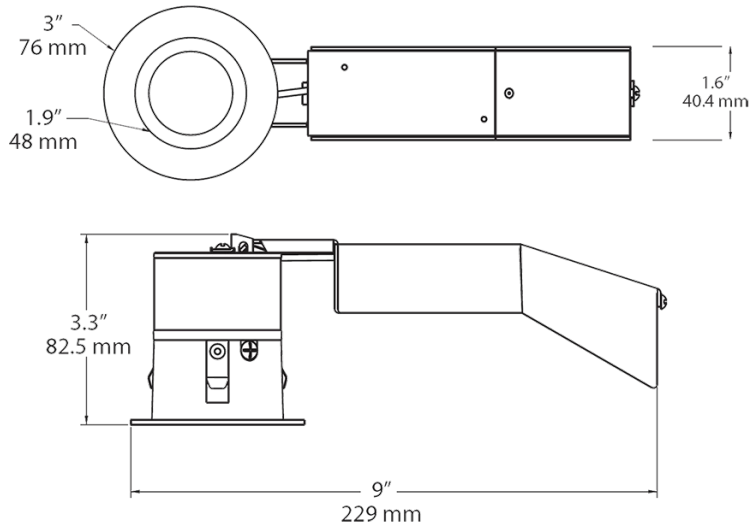

### Features

8W replaces 50W MR16 with energy savings of 82%

TRIAC dimmer compatibility for additional light control

Precision-engineered optics deliver smooth light without hot spots or glare

### Ordering Matrix

Family	Size	Shape	Watts	Beam Spread	Color Temp	CRI	Type	Finish
RDLED	2 = 2"	R = Round	8 = 8W	20 = 20° 30 = 30° 40 = 40° W = Wall Washer	YY = 2700K (Residential Warm) Y = 3000K (Warm) YN = 3500K (Warm Neutral) N = 4000K (Neutral)	Blank = 82 or 83 CRI HC = 90 CRI	T = 1/2" Trim TL = Trimless Look	S = Silver Trim