



Easy to install 4" rough-in with die-cast aperture ring, removable driver, thermal protector and adjustable butterfly brackets. This rough-in is designed to make new construction recessed downlighting easy Available with 80 or

Color: See Trim Module*

Weight: 2.0 lbs

Project:

Type:

Prepared By:

Date:

Driver Info

Type: Constant Current
 120V: 0.17A
 208V: 0.11A
 240V: 0.10A
 277V: 0.09A
 Input Watts: See Trim Module*
 Efficiency: N/A

LED Info

Watts: 20W
 Color Temp: See Trim Module*
 Color Accuracy: 90 CRI
 L70 Lifespan: N/A
 Lumens: See Trim Module*
 Efficacy: N/A

Technical Specifications

Listings

UL Listed:

Suitable for wet locations covered ceiling.

ENERGY STAR:

This product is ENERGY STAR® qualified.

Optical

Photometrics:

Photometrics are based on prorated reports. Contact the RAB Lighting Design department for the most up-to-date data.

Construction

Housing Component:

This component must be ordered with New Construction Round Trim Module in order to make a complete fixture.

Ambient Temperature:

Suitable for use in 40°C ambient temperatures.

Cold Weather Starting:

The minimum starting temperature is -40°C/-40°F

Aperture Size:

4" Rough-In.

Drop Ceiling Installation:

NDLED can be installed in drop ceiling tiles when using optional c-channel bars and following local construction codes.

Junction Box:

Integral junction box with wiring capacity for Min 90°C supply conductors 4 in 4 out

Mounting:

Housing includes nailer bars and butterfly brackets. Brackets also accommodate mounting with 1/4" to 1/2" bar stock, C channel or 1/2" conduit.

Easy Installation:

The EZConnector makes installation easy.

Thermal Protector:

Thermal protector included. Disables power if temperature exceeds safe operation levels.

Electrical

Driver:

ELV, 0-10V and TRIAC Dimming, Constant Current, Class 2, 120V-277V, 50/60Hz, Power Factor 98%, THD ≤ 20%.

Emergency Battery Backup:

Battery backup will operate the LED Lamp for 90 minutes if power fails. Wired for 120V.

Dimming Driver:

0 - 10V (at 120-277V), TRIAC and ELV (at 120V only).

Other

Equivalency:

DLED 20W is equivalent to 100W PAR.

Air Tight:

Housing certified Air Tight as per ASTM E283

California Title 24:

ND4R20F complies with 2013 California Title 24 building and electrical codes as a residential indoor fixture. See NDLED models with dimming drivers for products that comply as commercial indoor fixtures for general spaces. Any additional component requirements will be listed in the Title 24 section under technical specifications on the product page.

Warranty:

RAB warrants that our LED products will be free from defects in materials and workmanship for a period of five (5) years from the date of delivery to the end user, including coverage of light output, color stability, driver performance and fixture finish.

Country of Origin:

Designed by RAB in New Jersey and assembled in the USA by RAB's IBEW Local 3 workers.

Buy American Act Compliant:

This product is a COTS item manufactured in the United States, and is compliant with the Buy American Act.

Recovery Act (ARRA) Compliant:

This product complies with the 52.225-21 "Required Use of American Iron, Steel, and Manufactured Goods-- Buy American Act-- Construction Materials (October 2010).

Trade Agreements Act Compliant:

This product is a COTS item manufactured in the United States, and is compliant with the Trade Agreements Act.

GSA Schedule:

Suitable in accordance with FAR Subpart 25.4.

Dimensions

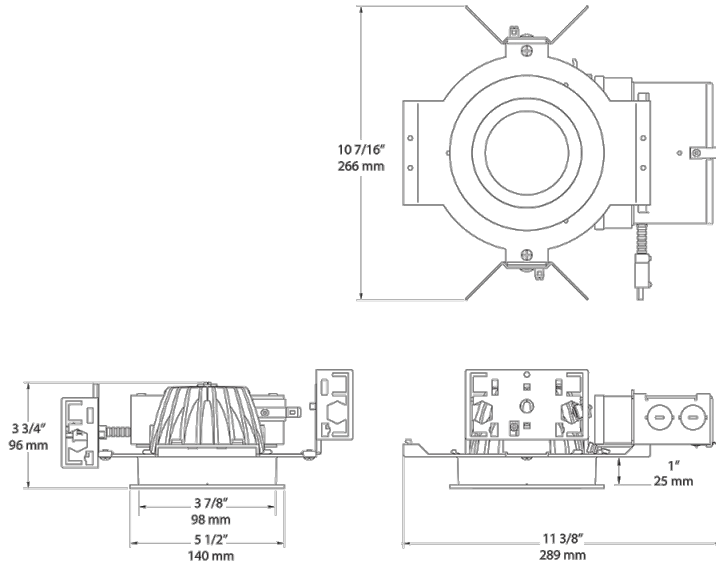

Features

- Butterfly bracket allows mounting with bar stock, "C" channel, 1/2" conduit or nailer bars
- Low-profile design allows for installation in ceilings with limited space
- Sturdy design with die cast aperture frame

Ordering Matrix

Family	Type	Size	Shape	Driver	Watts	Battery Backup
ND		4	R	D	20	/E2
	Blank = Standard IC = Insulation Contact (IC)	4 = 4"	R = Round	D = Universal Dimming	12 = 12W 20 = 20W	Blank = No Battery Backup /E2 = 120-277V Backup