



Mega performance, quality and value from state of the art 400 and 250 Watt HID floods with a full range of mounting options and accessories.

Color: Bronze

Weight: 33.0 lbs

<b>Project:</b>	<b>Type:</b>
<b>Prepared By:</b>	<b>Date:</b>

Lamp Info		Ballast Info	
Type:	ED37	Type:	CWA-HPF QT
Watts:	400W	120V:	N/A
Shape/Size:	N/A	208V:	2.0/2.3A
Base:	N/A	240V:	1.8/2.0A
ANSI:	N/A	277V:	1.5/1.8A
Hours:	20,000	Input Watts:	458W
Lamp Lumens:	36,000	Efficiency:	87%
Efficacy:	79 LPW		

## Technical Specifications

### Listings

#### UL Listing:

Suitable for wet locations. Suitable for ground mounting.

### Construction

#### Housing:

One-piece die cast aluminum with die cast door frame held captive when opened.

#### Reflector:

High quality anodized aluminum eliminates redirected energy to prolong lamp life. Contoured for maximum horizontal and vertical beam dispersion.

#### Finish:

Our environmentally friendly polyester powder coatings are formulated for high-durability and long-lasting color, and contains no VOC or toxic heavy metals.

#### Lens:

Thermal, tempered shock resistant glass, 5/32" thick.

#### Lens Gasket:

High temperature extruded silicone set in die cast retaining groove. Remains in place during relamping.

### EPA:

2.1

### Electrical

#### Socket:

3 socket positions customize beam spread to the application (center position is standard). Porcelain socket pulse rated 4kv, 1500 watts and 600 volts, reinforced with cat's eyes for added durability. Silicone and fiberglass #14 gauge socket leads rated for 200°C. Plated screw shell designed to resist corrosion with spring loaded center contact.

#### Quad Tap:

Fixture works with 120, 208, 240, and 277 volts.

#### Photocell:

Button Photocell 277V included. Photocell is compatible with 208V-277V.

### Other

#### Patents:

The unique RAB Megaflood is protected by U.S. Patents D565,772 and D570,024; China Patent ZL200730149208.0; Taiwan Patent D127,426 and Canada Patents D121,989 and D121,991

#### Country of Origin:

Designed by RAB in New Jersey and assembled in the USA by RAB's IBEW Local 3 workers.

### Buy American Act Compliant:

This product is a COTS item manufactured in the United States, and is compliant with the Buy American Act.

### Recovery Act (ARRA) Compliant:

This product complies with the 52.225-21 "Required Use of American Iron, Steel, and Manufactured Goods-- Buy American Act-- Construction Materials (October 2010).

### Trade Agreements Act Compliant:

This product is a COTS item manufactured in the United States, and is compliant with the Trade Agreements Act.

### GSA Schedule:

Suitable in accordance with FAR Subpart 25.4.

## Dimensions

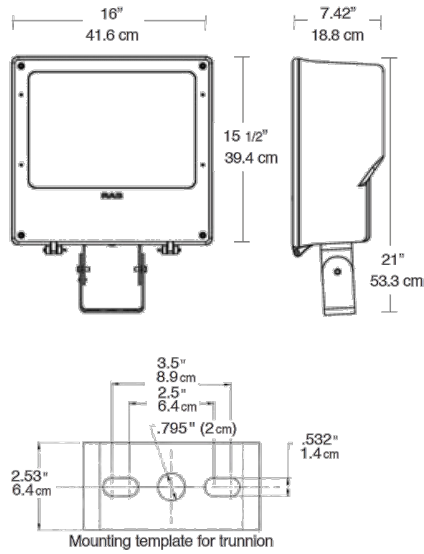

## Features

- Smaller size with lower EPA
- Water shedding design
- New Adjustable Reflector
- Die cast door frame held captive when opened
- Ballast compartment separated by anodized aluminum die formed wall
- Silicone gasket for durable weatherproofing & easy relamping
- Stainless steel external hardware