

MDLED1X12D10-40Y-W



The multi-head recessed gear tray comes in a variety of configurations and fits securely inside either the new construction or remodeler housings.

Color: White tray/white head

Weight: 2.8 lbs

Project:

Type:

Prepared By:

Date:

Driver Info

Type:	Constant Current
120V:	0.12A
208V:	0.08A
240V:	0.07A
277V:	0.06A
Input Watts:	15W
Efficiency:	78%

LED Info

Watts:	12W
Color Temp:	3000K
Color Accuracy:	90 CRI
L70 Lifespan:	N/A
Lumens:	917
Efficacy:	60 LPW

Technical Specifications

Listings

UL Listing:

Suitable for damp locations

IESNA LM-79 & LM-80 Testing:

RAB LED luminaires have been tested by an independent laboratory in accordance with IESNA LM-79 and LM-80, and have received the Department of Energy "Lighting Facts" label.

Construction

IC Rating:

Suitable for direct contact with insulation

Gear Tray Component:

This component must be ordered with Remodeler or New Construction housing in order to make a complete fixture.

Cold Weather Starting:

The minimum starting temperature is 14°F/-10°C. Ambient Temperature

Lens:

Nanostructure lens eliminates "hot spots", and provides smooth, uniform light at higher efficiency.

Reflector:

40°

Finish:

Our environmentally friendly polyester powder coatings are formulated for high-durability and long-lasting color, and contain no VOC or toxic heavy metals.

Green Technology:

Mercury and UV free. RoHS compliant components. Polyester powder coat finish formulated without the use of VOC or toxic heavy metals.

Electrical

Dimming Driver:

0-10V compatible dimmer as low as 10%.

Driver:

0-10V, Constant Current, Class 2, 120-277V, 50/60Hz, 350mA, 120V 0.17A, 277V 0.09A, Power Factor 99.4%, THD≤10%, Minimum Operating Temp 14° F (-100°C).

Other

Brackets:

Butterfly brackets allow mounting with 1/4 x 1/2" bar stock, C Channel, 1/2" conduit, or nailer bars.

Color Gels:

MDLED works great with third-party color gels to achieve a dramatic effect or a subtle accent. Plus, cool running LED won't degrade the gels like hot halogen lamps.

Tray and Heads:

Professional-grade, die-cast aluminum construction.

California Title 24:

MDLED1X12D10 complies with 2013 California Title 24 building and electrical codes as a commercial indoor fixture for general spaces when used with a vacancy sensor and 0-10V dimming control. Select a vacancy sensor using catalog number LVS800. 0-10V dimmer provided by others.

Warranty:

RAB warrants that our LED products will be free from defects in materials and workmanship for a period of five (5) years from the date of delivery to the end user, including coverage of light output, color stability, driver performance and fixture finish.

Country of Origin:

Designed by RAB in New Jersey and assembled in the USA by RAB's IBEW Local 3 workers.

Buy American Act Compliant:

This product is a COTS item manufactured in the United States, and is compliant with the Buy American Act.

Recovery Act (ARRA) Compliant:

This product complies with the 52.225-21 "Required Use of American Iron, Steel, and Manufactured Goods-- Buy American Act-- Construction Materials (October 2010).

Trade Agreements Act Compliant:

This product is a COTS item manufactured in the United States, and is compliant with the Trade Agreements Act.

GSA Schedule:

Suitable in accordance with FAR Subpart 25.4.

LED Characteristics

LED:

High-output, long-life LED with 2 step binning and integrated driver technology.

Color Consistency:

2-step MacAdam Ellipse binning to achieve consistent fixture-to-fixture color.

Color Stability:

LED color temperature is warranted to shift no more than 200K in CCT over a 5 year period.

Dimensions

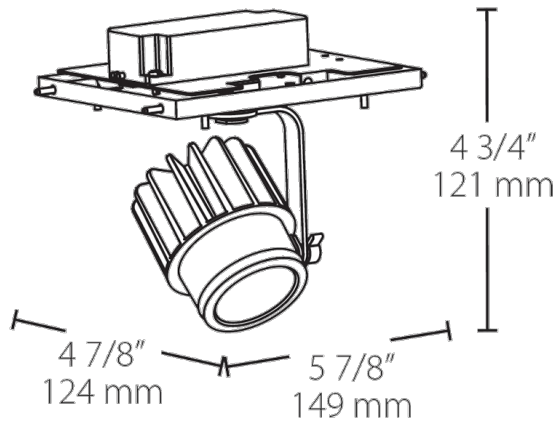

Features

Single 12 Watt LED head

Fixture head rotates a full 360° and tilts up to 45°

Easily lock head in place with a thumb screw

Tool-less adjustment for 3 discrete positions: full recess, flush mount or semi-recessed