



Flush mount canopy fixture ideal for vehicle service and fueling stations as a retrofit or new construction installation. 16" x 16" models offered in two power packages with an equivalency range from 150W to 250W Metal Halide. Also available in 20" x 20" models with three power packages.

Color: White

Weight: 26.7 lbs

<b>Project:</b>	<b>Type:</b>
<b>Prepared By:</b>	<b>Date:</b>

Driver Info		LED Info	
Type:	Constant Current	Watts:	52W
120V:	N/A	Color Temp:	3000K
208V:	N/A	Color Accuracy:	71 CRI
240V:	N/A	L70 Lifespan:	100000
277V:	N/A	Lumens:	6,313
Input Watts:	54W	Efficacy:	117 LPW
Efficiency:	97%		

## Technical Specifications

### Listings

#### UL Listing:

Suitable for wet locations.

#### IESNA LM-79 & LM-80 Testing:

RAB LED luminaires have been tested by an independent laboratory in accordance with IESNA LM-79 and LM-80, and have received the Department of Energy "Lighting Facts" label.

### Electrical

#### Driver:

Constant Current, Class 2 347-480V, 50/60 Hz. THD <20%. PF >0.90, 1400mA

### Optical

#### BUG Rating:

B2 U0 G1

### Construction

#### IP Rating:

Ingress Protection rating of IP66 for dust and water.

#### Maximum Ambient Temperature:

Suitable for use in 40°C (104°F) ambient temperatures

#### Cold Weather Starting:

Minimum starting temperature is -40°F/-40°C

#### Housing:

Die-cast aluminum with stainless steel cover

#### Mounting:

Semi-recessed construction. Junction box with four (4) 1/2" NPS conduit openings.

#### Lens:

Tempered glass

#### Gaskets:

High-temperature silicone gaskets

#### Retroplate:

An optional retroplate allows for installation in openings from 4 to 6.5 inches in diameter. Additional retrofit options are available upon request to replace virtually any existing fixture. Please contact RAB Customer Service 1-888-722-1000.

#### Finish:

Our environmentally friendly polyester powder coatings are formulated for high-durability and long-lasting color, and contain no VOC or toxic heavy metals.

#### Green Technology:

Mercury and UV free. RoHS compliant components. Polyester powder coat finish formulated without the use of VOC or toxic heavy metals.

### LED Characteristics

#### Lifespan:

100,000-hour LED lifespan based on IES LM-80 results and TM-21 calculations.

#### LEDs:

Long-life, high-efficiency surface mount LEDs

#### Color Consistency:

7-step MacAdam Ellipse binning to achieve consistent fixture-to-fixture color.

#### Color Stability:

RAB LEDs exceed industry standards for chromatic stability.

#### Color Uniformity:

RAB's range of CCT (Correlated Color Temperature) follows the guidelines of the American National Standard for Specifications for the Chromaticity of Solid State Lighting (SSL) Products, ANSI C78.377-2011.

### Other

#### Equivalency:

MASI™ 52W replaces 150W metal halide.

#### Country of Origin:

Designed by RAB in New Jersey and assembled in the USA by RAB's IBEW Local 3 workers.

#### Buy American Act Compliant:

This product is a COTS item manufactured in the United States, and is compliant with the Buy American Act.

#### Trade Agreements Act Compliant:

This product is a COTS item manufactured in the United States, and is compliant with the Trade Agreements Act.

#### GSA Schedule:

Suitable in accordance with FAR Subpart 25.4.

#### California Title 24:

Please refer to MASI models with 0-10V dimming drivers for fixtures that comply with 2013 California Title 24 building and electrical codes.

#### Warranty:

RAB warrants that our LED products will be free from defects in materials and workmanship for a period of five (5) years from the date of delivery to the end user, including coverage of light output, color stability, driver performance and fixture finish.

## Dimensions

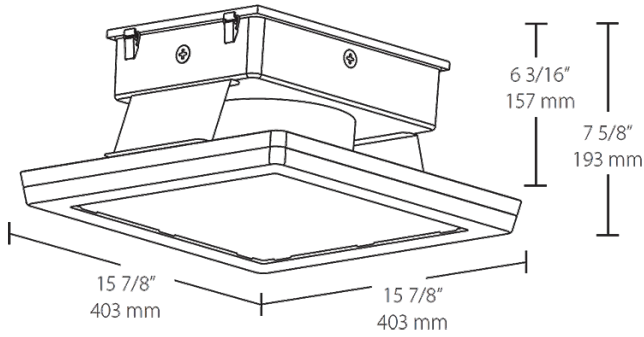

## Features

- All 120-277V models DLC Premium listed, qualifying for highest available utility rebates
- Premium performance, ultra-high efficiency for fastest payback
- Easily installs in 4" openings and replaces most existing fixtures
- Retroplate accessory available for openings larger than 4"
- Water-resistant junction box and drain-off slots
- 5-Year bumper-to-bumper warranty

## Ordering Matrix

Family	Size	Watts	Color Temp	Finish	Dimming	Voltage
MASI	16 = 16" x 16"	52 = 52W 80 = 80W 100 = 100W	Blank = 5000K (Cool) Y = 3000K (Warm) N = 4000K (Neutral)	W = White	Blank = No Dimming /D10 = Dimmable	Blank = 120-277V /480 = 480V