



Low profile, low glare. Edge-lit technology unlike any other.

Color: Bronze

Weight: 20.0 lbs

Project:	Type:
Prepared By:	Date:

Driver Info		LED Info	
Type:	Constant Current	Watts:	38W
120V:	N/A	Color Temp:	5000K (Cool)
208V:	N/A	Color Accuracy:	76 CRI
240V:	N/A	L70 Lifespan:	100,000
277V:	N/A	Lumens:	5,163
Input Watts:	42W	Efficacy:	122 LPW
Efficiency:	90%		

Technical Specifications

Lightcloud

Lightcloud Controller Installed:

Fixture, Zone, and plug-load control from one powerful device. Capable of switching, 0-10V dimming, power monitoring. Can also be used to extend the range of the Lightcloud mesh network. Attach to fixture, junction box, or electrical panel.

Listings

UL Listing:

Suitable for wet locations

IESNA LM-79 & IESNA LM-80 Testing:

RAB LED luminaires have been tested by an independent laboratory in accordance with IESNA LM-79 and LM-80

Title 24 Compliant:

An IVELOT edge-lit area light can be used with a motion sensor or photocell control option to comply with 2016 Title 24 Part 6 Section 130.2 (a,b,v)

Electrical

Driver:

Class 2, 50/60Hz, 347-480V 4kV standard, 10kV optional

Dimming Driver:

Driver includes dimming control wiring for 0-10V dimming systems. Requires separate 0-10V DC dimming circuit. Dims as low as 10%.

THD:

12.75% at 480V

Power Factor:

95.4% at 480V

LED Characteristics

Lifespan:

100,000-hour LED lifespan based on IES LM-80 results and TM-21 calculations at 25°C

LEDs:

Long-life, High efficiency, micro-power, surface mount LEDs

Color Stability:

LED color temperature is warrantied to shift no more than 200K in CCT over a 5 year period

Color Uniformity:

RAB's range of CCT (Correlated Color Temperature) follows the guidelines of the American National Standard for Specifications for the Chromaticity of Solid State Lighting (SSL) Products, ANSI C78.377-2017.

Construction

IP Rating:

Ingress Protection rating of IP66 for dust and water

Cold Weather Starting:

Minimum starting temperature is -40°C (-40°F)

Maximum Ambient Temperature:

Suitable for use in 40°C (104°F)

Housing:

Precision die-cast aluminum

IES Classification:

The Forward Throw distribution is especially suited for mounting on the sides of buildings and walls, and for illuminating the perimeter of parking areas. It produces a semiCircular distribution with essentially the same candlepower at lateral angles from 90° to 270°.

Mounting:

Wall mount

Lens:

Diffused Polymethyl Methacrylate (PMMA)

Effective Projected Area:

EPA = 0.61

Finish:

Formulated for high-durability and long lasting color

Green Technology:

Mercury and UV-free. RoHS compliant components.

Sensor Specifications

Multi Level Motion Sensor:

*100 ft. diameter maximum coverage from 40 ft. height.

Other

Warranty:

RAB warrants that our LED products will be free from defects in materials and workmanship for a period of five (5) years from the date of delivery to the end user, including coverage of light output, color stability, driver performance and fixture finish. RAB's warranty is subject to all terms and conditions found at

Buy American Act Compliance:

RAB values USA manufacturing! Upon request, RAB may be able to manufacture this product to be compliant with the Buy American Act (BAA). Please contact customer service to request a quote for the product to be made BAA compliant.

Dimensions

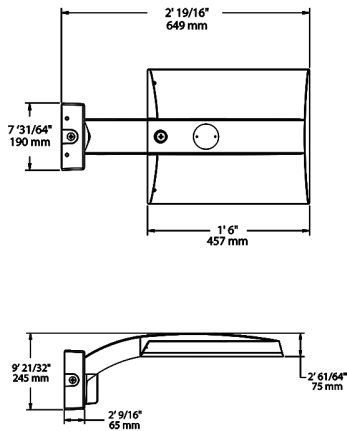

Features

- 0-10V Dimming, standard
- 100,000-Hour LED lifespan

Ordering Matrix

Family	Distribution	Lumen Output	Mounting	CRI/CCT	Finish	Voltage/Driver	Sensor Options	Lightcloud Option
IVA	FT	45L	WM	750	Z	H	/WS4	/LC
T2 = Type II		45L = 4,500 lumens (38W)	PA = Universal Pole Adapter	750 = 70CRI 5000K	Z = Bronze	U = 120-277V 0-10V Dimming	Blank = No Options	Blank = No Lightcloud
T3 = Type III					W = White		/WS = 8ft lens Wattstopper	/LC = Lightcloud Controller
T4 = Type IV		75L = 7,500 lumens (67W)	WM = Wall mount	740 = 70CRI 4000K	G = Roadway Gray	H = 347-480V, 0-10V Dimming	/WS2 = 20ft lens Wattstopper	
T5S = Type V Square		100L = 10,000 lumens (94W)	SF = Slipfitter	730 = 70CRI 3000K	K = Black		/WS4 = 40ft lens Wattstopper	
FT = Forward Throw		130L = 13,000 lumens (117W)					/7PR = 7-pin receptacle	