

## Antique Bronze Frame with Frosted Lens with Grill Style #2

*Note: Fixture will come fully assembled with the frame and lens shown above.*

<b>Project:</b>	<b>Type:</b>
<b>Prepared By:</b>	<b>Date:</b>

Driver Info		LED Info	
Type:	Constant Current	Watts:	25W
120V:	0.22A	Color Temp:	3000K (Warm)
208V:	0.13A	Color Accuracy:	94 CRI
240V:	0.11A	R9:	65
277V:	0.1A	L70 Lifespan:	50,000
Input Watts:	26W	Lumens:	1,344
Efficiency:	97%	Efficacy:	52 LPW

## Technical Specifications

### Listings

#### UL Listed:

Suitable for damp locations. Recommended for indoor use only.

#### ADA Compliant:

Meets ADA Requirements for wall-mounted luminaires.

#### IESNA LM-79 & IESNA LM-80 Testing:

RAB LED luminaires and LED components have been tested by an independent laboratory in accordance with IESNA LM-79 and LM-80.

### LED Characteristics

#### Lifespan:

50,000-hour LED lifespan based on IES LM-80 results and TM-21 calculations

#### LEDs:

Long-life, High efficiency, micro-power, surface mount LEDs; binned and mixed for uniform light output and color

#### Light Loss Factor:

0.18

#### Color Stability:

LED color temperature is warranted to shift no more than 200K in CCT over a 5 year period

#### Color Uniformity:

RAB's range of CCT (Correlated Color Temperature) follows the guidelines of the American National Standard for Specifications for the Chromaticity of Solid State Lighting (SSL) Products, ANSI C78.377-2017.

### Electrical

#### Dimming Driver:

0 - 10V (at 120-277V), TRIAC and ELV (at 120V only)

#### Battery Backup:

Battery backup will operate the LED Lamp for 90 minutes if power fails. Wired for 120V-277V.

#### Driver:

Constant Current, Class 2, 120-277VAC, 50/60Hz, 350mA or 640mA

#### THD:

12.6% at 120V, 16.1% at 277V

#### Power Factor:

98.4% at 120V, 94.3% at 277V

### Construction

#### Housing:

Die-cast and extruded aluminum

#### Mounting:

Wall mount with junction box included

#### Lens:

Frosted polycarbonate with grill style #2. See for cleaning instructions.

#### Ambient Operating Temperature:

-20°C (-4°F) to 40°C (104°F)

#### Green Technology:

Mercury and UV-free. RoHS compliant components.

#### Finish:

Luxuriously Electroplated Antique Bronze

### Sensor Specifications

#### Capacitance Load:

400VA at 120VAC, 800VA at 230VAC, 1000VA at 277VAC

#### Operating Temperature:

-20°C to +60°C (-4°F to +140°F)

#### Relay:

Zero-cross relay

#### Maximum Mounting Height:

16.4 feet

#### Customizable Detection Area:

10, 50, 75 or 100%

#### Time Delay:

5s, 30s, 1min, 5min, 10min, 20min, 30min

#### Cut Off Period:

0s, 10s, 1min, 5min, 10min, 30min, 1hr, Bi-Level

## Technical Specifications (continued)

### Sensor Specifications

#### Cut-Off Dimming level:

10, 20, 30, 50%

#### Cut-Off Power:

Less than 1W

#### Daylight Threshold:

About .2-5 fc for disabled

#### Sensor Principle:

High Frequency

#### Microwave Frequency:

5.8GHz +/- 75MHz

#### Microwave Power:

<0.2mW

#### Max Detection Range:

26 ft. diameter at 16 ft. mounting height

#### Detection Angle:

About 30 to 150 degrees

#### Remote Control:

Adjust settings using remote control (catalog# MVSREM). Only available with 0-10V dimming driver options.

#### Other

#### Equivalency :

Equivalent to 100W Incandescent

#### Warranty:

RAB warrants that our LED products will be free from defects in materials and workmanship for a period of five (5) years from the date of delivery to the end user, including coverage of light output, color stability, driver performance and fixture finish. RAB's warranty is subject to all terms and conditions found at

#### Buy American Act Compliance:

RAB values USA manufacturing! Upon request, RAB may be able to manufacture this product to be compliant with the Buy American Act (BAA). Please contact customer service to request a quote for the product to be made BAA compliant.

## Dimensions

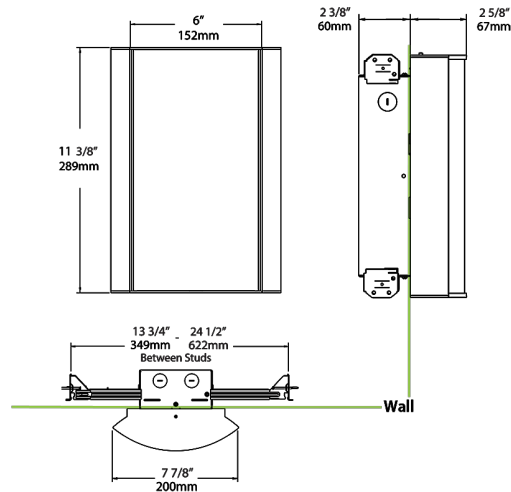

## Ordering Matrix

Family	Lumen Package	CRI and CCT		Lens		Finish	Options
HALVS	18L	930	–	FG2	–	A	/MVS/E2
	<b>10L</b> = 1000lm / 14W <b>18L</b> = 1800lm / 25W	<b>940</b> = 90CRI, 4000K <b>935</b> = 90CRI, 3500K <b>930</b> = 90CRI, 3000K <b>927</b> = 90CRI, 2700K		<b>F</b> = Frosted (Standard) <b>FG1</b> = Frosted with Grill Style #1 <b>FG2</b> = Frosted with Grill Style #2 <b>FG3</b> = Frosted with Grill Style #3 <b>NL</b> = Natural Leaves <b>GL</b> = Green Leaves <b>TL</b> = Toffee Leaves <b>LW</b> = Linen Hampton White <b>LS</b> = Linen Stone <b>LH</b> = Linen Harbor <b>MS</b> = Metallic Spun Silver <b>MC</b> = Metallic Spun Copper <b>MG</b> = Metallic Spun Gold <b>CW</b> = Crush Polar White <b>CS</b> = Crush Sedona <b>MP</b> = Mirage Platinum <b>MA</b> = Mirage Bronze		<b>W</b> = White <b>K</b> = Black <b>S</b> = Silver <b>A</b> = Antique Bronze <b>SA</b> = Satin Nickel <b>CU</b> = Copper	<b>Blank</b> = No Option <b>/E2</b> = Emergency Battery Backup <b>/MVS</b> = Occupancy Sensor <b>/BL</b> = Bi-Level Control <b>/LC</b> = Lightcloud Controller <b>/MVS/E2</b> = Microwave Sensor w/ Emergency Battery Backup <b>/BL/E2</b> = Bi-Level Control w/ Emergency Battery Backup <b>/LC/E2</b> = Lightcloud Controller w/ Emergency Battery Backup