



Textured Silver Frame with Frosted Lens with Grill Style #2

Note: Fixture will come fully assembled with the frame and lens shown above.

Project:	Type:
Prepared By:	Date:

Driver Info		LED Info	
Type:	Constant Current	Watts:	14W
120V:	0.12A	Color Temp:	3000K (Warm)
208V:	0.07A	Color Accuracy:	94 CRI
240V:	0.06A	R9:	65
277V:	0.06A	L70 Lifespan:	50,000
Input Watts:	14W	Lumens:	790
Efficiency:	N/A	Efficacy:	56 LPW

Technical Specifications

Listings

UL Listed:

Suitable for damp locations. Recommended for indoor use only.

ADA Compliant:

Meets ADA Requirements for wall-mounted luminaires.

IESNA LM-79 & IESNA LM-80 Testing:

RAB LED luminaires and LED components have been tested by an independent laboratory in accordance with IESNA LM-79 and LM-80.

LED Characteristics

Lifespan:

50,000-hour LED lifespan based on IES LM-80 results and TM-21 calculations

LEDs:

Long-life, High efficiency, micro-power, surface mount LEDs; binned and mixed for uniform light output and color

Light Loss Factor:

0.33

Color Stability:

LED color temperature is warranted to shift no more than 200K in CCT over a 5 year period

Color Uniformity:

RAB's range of CCT (Correlated Color Temperature) follows the guidelines of the American National Standard for Specifications for the Chromaticity of Solid State Lighting (SSL) Products, ANSI C78.377-2017.

Electrical

Dimming Driver:

0 - 10V (at 120-277V), TRIAC and ELV (at 120V only)

Battery Backup:

Battery backup will operate the LED Lamp for 90 minutes if power fails. Wired for 120V-277V.

Driver:

Constant Current, Class 2, 120-277VAC, 50/60Hz, 350mA or 640mA

THD:

19.8% at 120V, 21.6% at 277V

Power Factor:

96.4% at 120V, 85.7% at 277V

Construction

Housing:

Die-cast and extruded aluminum

Mounting:

Wall mount with junction box included

Lens:

Frosted polycarbonate with grill style #2. See for cleaning instructions.

Ambient Operating Temperature:

-20°C (-4°F) to 40°C (104°F)

Green Technology:

Mercury and UV-free. RoHS compliant components.

Finish:

Textured Silver using our environmentally friendly polyester powder coatings are formulated for high-durability and long-lasting color

Sensor Specifications

Capacitance Load:

400VA at 120VAC, 800VA at 230VAC, 1000VA at 277VAC

Operating Temperature:

-20°C to +60°C (-4°F to +140°F)

Relay:

Zero-cross relay

Maximum Mounting Height:

16.4 feet

Customizable Detection Area:

10, 50, 75 or 100%

Time Delay:

5s, 30s, 1min, 5min, 10min, 20min, 30min

Cut Off Period:

0s, 10s, 1min, 5min, 10min, 30min, 1hr, Bi-Level

Technical Specifications (continued)

Sensor Specifications

Cut-Off Dimming level:

10, 20, 30, 50%

Cut-Off Power:

Less than 1W

Daylight Threshold:

About .2-5 fc for disabled

Sensor Principle:

High Frequency

Microwave Frequency:

5.8GHz +/- 75MHz

Microwave Power:

<0.2mW

Max Detection Range:

26 ft. diameter at 16 ft. mounting height

Detection Angle:

About 30 to 150 degrees

Remote Control:

Adjust settings using remote control (catalog# MVSREM). Only available with 0-10V dimming driver options.

Other

Equivalency :

Equivalent to 60W Incandescent

Warranty:

RAB warrants that our LED products will be free from defects in materials and workmanship for a period of five (5) years from the date of delivery to the end user, including coverage of light output, color stability, driver performance and fixture finish. RAB's warranty is subject to all terms and conditions found at

Buy American Act Compliance:

RAB values USA manufacturing! Upon request, RAB may be able to manufacture this product to be compliant with the Buy American Act (BAA). Please contact customer service to request a quote for the product to be made BAA compliant.

Dimensions

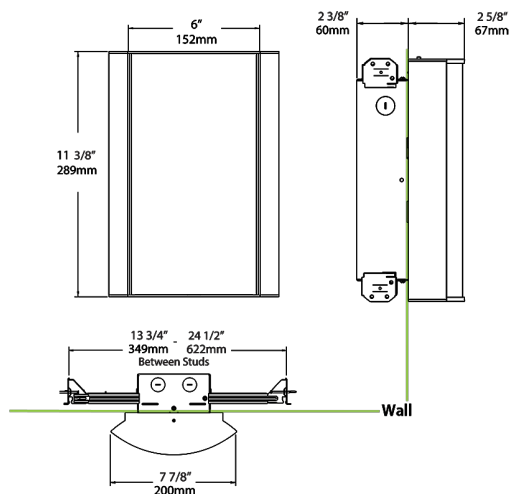

Ordering Matrix

Family	Lumen Package	CRI and CCT		Lens		Finish	Options
HALVS	10L	930	–	FG2	–	S	/MVS/E2
	10L = 1000lm / 14W 18L = 1800lm / 25W	940 = 90CRI, 4000K 935 = 90CRI, 3500K 930 = 90CRI, 3000K 927 = 90CRI, 2700K		F = Frosted (Standard) FG1 = Frosted with Grill Style #1 FG2 = Frosted with Grill Style #2 FG3 = Frosted with Grill Style #3 NL = Natural Leaves GL = Green Leaves TL = Toffee Leaves LW = Linen Hampton White LS = Linen Stone LH = Linen Harbor MS = Metallic Spun Silver MC = Metallic Spun Copper MG = Metallic Spun Gold CW = Crush Polar White CS = Crush Sedona MP = Mirage Platinum MA = Mirage Bronze		W = White K = Black S = Silver A = Antique Bronze SA = Satin Nickel CU = Copper	Blank = No Option /E2 = Emergency Battery Backup /MVS = Occupancy Sensor /BL = Bi-Level Control /LC = Lightcloud Controller /MVS/E2 = Microwave Sensor w/ Emergency Battery Backup /BL/E2 = Bi-Level Control w/ Emergency Battery Backup /LC/E2 = Lightcloud Controller w/ Emergency Battery Backup