



New Integra Hood for Friendly Lighting. Awesome performance with quality and value from this compact 400 and 250 Watt HID flood.

Color: Bronze

Weight: 32.8 lbs

Project:	Type:
Prepared By:	Date:

Lamp Info		Ballast Info	
Type:	ED18	Type:	CWA-HPF QT
Watts:	250W	120V:	1.7/2.5A
Shape/Size:	N/A	208V:	N/A
Base:	N/A	240V:	N/A
ANSI:	N/A	277V:	N/A
Hours:	24,000	Input Watts:	295W
Lamp Lumens:	28,500	Efficiency:	85%
Efficacy:	97 LPW		

Technical Specifications

Listings

UL Listing:

Suitable for wet locations. Suitable for ground mounting.

Construction

Housing:

Precision die cast aluminum.

Reflector:

High quality anodized aluminum.

Lens:

Tempered shock resistant glass.

Lens Gasket:

Molded one-piece silicone in die cast retaining groove to remain in place during relamping.

Finish:

Our environmentally friendly polyester powder coatings are formulated for high-durability and long-lasting color, and contains no VOC or toxic heavy metals.

EPA:

1.3.

Electrical

Socket:

Glazed porcelain 4kv pulse rated with nickel plated screw shell and spring contacts.

Quad Tap:

Fixture works with 120, 208, 240, and 277 volts.

Photocell:

Button Photocell 120V included. Photocell is only compatible with 120V.

Other

Patents:

Pat. D547,478.

Country of Origin:

Designed by RAB in New Jersey and assembled in the USA by RAB's IBEW Local 3 workers.

Buy American Act Compliant:

This product is a COTS item manufactured in the United States, and is compliant with the Buy American Act.

Recovery Act (ARRA) Compliant:

This product complies with the 52.225-21 "Required Use of American Iron, Steel, and Manufactured Goods-- Buy American Act-- Construction Materials (October 2010).

Trade Agreements Act Compliant:

This product is a COTS item manufactured in the United States, and is compliant with the Trade Agreements Act.

GSA Schedule:

Suitable in accordance with FAR Subpart 25.4.

Dimensions

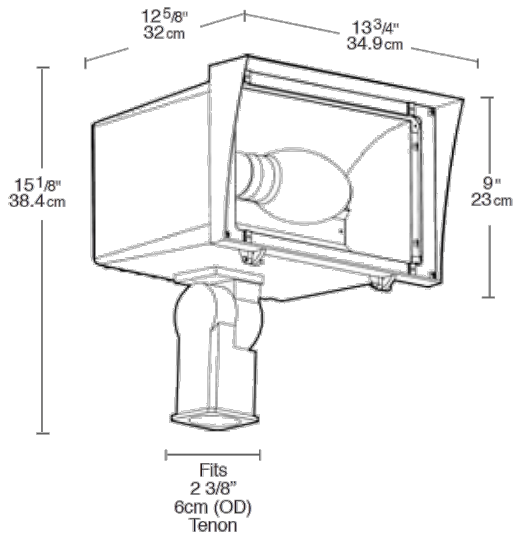

Features

- Optional glare hood, wire guard or polycarbonate shield
- Reflector designed for precise beam control
- Stainless steel screws included
- Long life lamp included
- Supplied with 3' of STW cord
- Rugged trunnion or slipfitter mounting
- New 2" Integra hood to reduce light trespass and glare