



Specification Grade 400 and 250 Watt HID floodlight with cutting edge design, architectural quality, superior features and mounting options at competitive prices.

Color: Bronze

Weight: 33.0 lbs

Project:	Type:
Prepared By:	Date:

Lamp Info		Ballast Info	
Type:	ED28	Type:	CWA-HPF QT
Watts:	400W	120V:	N/A
Shape/Size:	N/A	208V:	2.0/2.3A
Base:	N/A	240V:	1.8/2.0A
ANSI:	N/A	277V:	1.5/1.8A
Hours:	20,000	Input Watts:	450W
Lamp Lumens:	40,000	Efficiency:	89%
Efficacy:	89 LPW		

Technical Specifications

Listings

UL Listing:

Suitable for wet locations. Suitable for ground mounting.

EISA 2007 Compliant:

This product complies with the new law for metal halide ballast efficiency. This law goes into effect January 1st, 2008. Pulse Start offers Longer Lamp Life, Faster Startup and Faster Restrike.

Construction

Housing:

Precision die cast aluminum with Wall Bracket, Trunnion or Slipfitter.

Reflector:

Anodized aluminum. Field adjustable beam spread.

Lens Frame & Glare Shield:

Precision die cast aluminum. Hinged for easy access. Phillips head screws for added security.

Finish:

Our environmentally friendly polyester powder coatings are formulated for high-durability and long-lasting color, and contains no VOC or toxic heavy metals.

Lens:

Thermal tempered shock resistant glass, 3/16" thick.

Lens Gasket:

High temperature one piece molded silicone set in die cast retaining groove. Remains in place during relamping.

EPA:

Maximum EPA 2.0.

Electrical

Socket:

HID Porcelain 4kv Pulse Rated socket with nickel plated screw shell CFL Plug in type, GX24q-4 base.

Photocell:

Button Photocell 277V included. Photocell is compatible with 208V-277V.s.

Pulse Start:

Pulse Start metal halide for increased lamp life, lumen maintenance, color uniformity and efficiency.

Other

Patents:

Pat. D550,387.

Country of Origin:

Designed by RAB in New Jersey and assembled in the USA by RAB's IBEW Local 3 workers.

Buy American Act Compliant:

This product is a COTS item manufactured in the United States, and is compliant with the Buy American Act.

Recovery Act (ARRA) Compliant:

This product complies with the 52.225-21 "Required Use of American Iron, Steel, and Manufactured Goods-- Buy American Act-- Construction Materials (October 2010).

Trade Agreements Act Compliant:

This product is a COTS item manufactured in the United States, and is compliant with the Trade Agreements Act.

GSA Schedule:

Suitable in accordance with FAR Subpart 25.4.

Dimensions

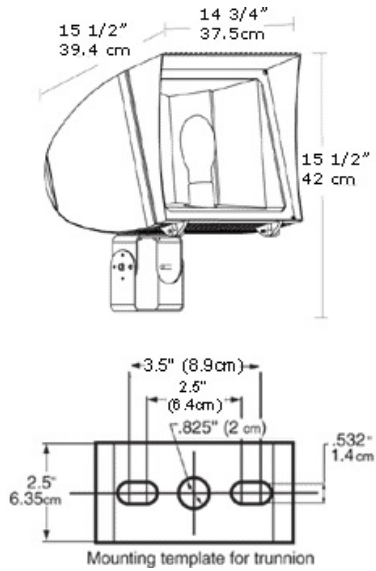

Features

- Integra hood glare shield for friendly lighting when properly aimed
- Silicone gasket for durable weatherproofing & easy relamping
- Precision die cast aluminum housing and lens frame with durable polyester powder coating
- Anodized aluminum reflector
- Mogul base 4kv pulse rated socket
- Two field adjustable socket positions allow fine tuning of beam spread
- Fins for heat dissipation extend lamp and ballast life