



Color: Bronze

Weight: 20.9 lbs

Project:

Type:

Prepared By:

Date:

Driver Info

Type	Constant Current
120V	N/A
208V	N/A
240V	N/A
277V	N/A
Input Watts	82.2W

LED Info

Watts	78W
Color Temp	N/A
Color Accuracy	N/A
L70 Lifespan	N/A
Lumens	10,777
Efficacy	131.1 lm/W

Technical Specifications

Listings

UL Listed:

Suitable for wet locations. Suitable for mounting within 1.2m (4ft) of the ground.

IESNA LM-79 & IESNA LM-80 Testing:

RAB LED luminaires and LED components have been tested by an independent laboratory in accordance with IESNA LM-79 and LM-80.

LED Characteristics

Lifespan:

100,000-hour LED lifespan based on IES LM-80 results and TM-21 calculations

LEDs:

Long-life, high-efficacy, surface-mount LEDs

Color Stability:

LED color temperature is warranted to shift no more than 200K in color temperature over a 5-year period

Color Uniformity:

RAB's range of Correlated Color Temperature follows the guidelines of the American National Standard for Specifications for the Chromaticity of Solid State Lighting (SSL) Products, ANSI C78.377-2017.

Electrical

Driver:

Constant Current, Class 2, 480V, 50/60 Hz, 480V: 0.24A

THD:

5.07% at 480V

Power Factor:

99.8% at 480V

Note:

All values are typical (tolerance +/- 10%)

7-Pin Receptacle:

ANSI C136.41 7-pin receptacle

Photocell:

480V twistlock photocell Included. Photocell is only compatible with 480V.

Construction

IP Rating:

Ingress Protection rating of IP66 for dust and water

EPA:

2

Technical Specifications (continued)

Construction

Ambient Temperature:

Suitable for -40°C (-40°F) to 40°C (104°F)

Lens:

Tempered glass lens included

Housing:

Die-cast aluminum housing and door frame

Mounting:

Heavy-duty slipfitter for 2 3/8"OD pipe

Finish:

Formulated for high durability and long-lasting color

Other

Equivalency:

Equivalent to 250W Metal Halide

Warranty:

RAB warrants that our LED products will be free from defects in materials and workmanship for a period of five (5) years from the date of delivery to the end user, including coverage of light output, color stability, driver performance and fixture finish. RAB's warranty is subject to all terms and conditions found at rablighting.com/warranty.

Buy American Act Compliance:

RAB values USA manufacturing! Upon request, RAB may be able to manufacture this product to be compliant with the Buy American Act (BAA). Please contact customer service to request a quote for the product to be made BAA compliant.

Dimensions

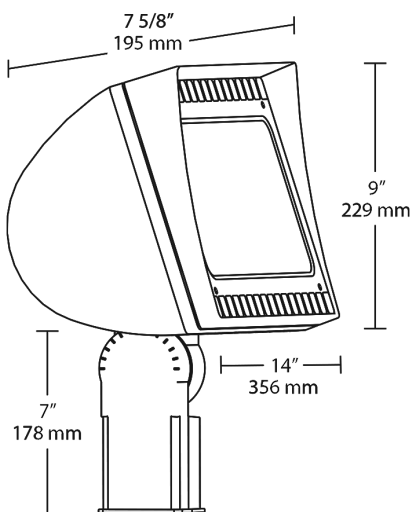

Features

- 66% energy cost savings vs. HID
- NEMA Type - 6H x 6V
- "Air-Flow" technology heat dissipation
- 100,000-hour LED lifespan
- 5-Year, No-Compromise Warranty

Ordering Matrix

Family	Wattage	Mounting	Color Temp	Finish	Driver	Options	Other Option
FXLED	78	SF	N		/480	/7PR/PCT4	
	78 = 78W 105 = 105W 125 = 125W 150 = 150W	SF = Slipfitter T = Trunnion	Blank = 5000K (Cool) N = 4000K (Neutral) Y = 3000K (Warm)	Blank = Bronze W = White	Blank = Standard /D10 = 0-10V Dimming /BL = Bi-Level /480 = 480V	Blank = No Option /LC = Lightcloud® Control /PCT = 100-277V Twistlock /PCT4 = 480V Twistlock	Blank = Standard USA = BAA Compliant