

FXLED200SFYB46/BL



Ultra high output, high efficiency LED floodlight with NEMA Types: 7H x 6V, 6H x 4V, 4H x 6V, 5H x 5V and 3H x 3V. Patent Pending airflow technology ensures long LED and driver lifespan. Use for general and security lighting for large areas, building facades, signs and landscapes.

Color: Bronze

Weight: 66.1 lbs

Project:

Type:

Prepared By:

Date:

Driver Info

Type:	Constant Current
120V:	1.72A
208V:	1.03A
240V:	0.89A
277V:	0.77A
Input Watts:	205W
Efficiency:	98%

LED Info

Watts:	200W
Color Temp:	3000K
Color Accuracy:	81 CRI
L70 Lifespan:	100000
Lumens:	21,301
Efficacy:	104 LPW

Technical Specifications

Listings

UL Listing:

Suitable for wet locations. Suitable for ground mounting.

IESNA LM-79 & LM-80 Testing:

RAB LED luminaires have been tested by an independent laboratory in accordance with IESNA LM-79 and LM-80, and have been received the Department of Energy "Lighting Facts" label.

Electrical

Drivers:

Constant Current, 700mA, 50/60 Hz, 120-277V, 4 kV surge protection, 120V: 1.72A, 208V: 1.03A, 240V: 0.89A, 277V: 0.277A, THD <20%, Power Factor: 99%

THD:

4.1% at 120V, 10.6% at 277V

Optical

NEMA Type:

NEMA Beam Spread of 4H x 6V

LED Characteristics

Lifespan:

100,000-hour LED lifespan based on IES LM-80 results and TM-21 calculations.

LEDs:

Multi-chip, high-output, long-life LEDs

Color Consistency:

3-step MacAdam Ellipse binning to achieve consistent fixture-to-fixture color.

Color Stability:

LED color temperature is warranted to shift no more than 200K in CCT over a 5 year period.

Color Uniformity:

RAB's range of CCT (Correlated Color Temperature) follows the guidelines of the American National Standard for Specifications for the Chromaticity of Solid State Lighting (SSL) Products, ANSI C78.377-2011.

Construction

IP Rating:

Ingress Protection rating of IP66 for dust and water.

Maximum Ambient Temperature:

Suitable for use in 40°C (104°F) ambient temperatures

Effective Projected Area:

EPA = 4

Cold Weather Starting:

The minimum starting temperature is -40°C/-40°F

Thermal Management:

Superior thermal management with external Air-Flow fins.

Housing:

Die-cast aluminum housing and door frame

Mounting:

Heavy-duty Slipfitter for 2 3/8"OD pipe.

Reflector:

Specular and semi-specular vacuum metalized polycarbonate

Gaskets:

High-temperature silicone gaskets

Finish:

Our environmentally friendly polyester powder coatings are formulated for high-durability and long-lasting color, and contains no VOC or toxic heavy metals.

Green Technology:

Mercury and UV free. RoHS compliant components. Polyester powder coat finish formulated without the use of VOC or toxic heavy metals.

Other

California Title 24:

FXLED200SF/BL with bi-level operation complies with 2013 California Title 24 building and electrical codes as a commercial outdoor pole-mounted fixture > 30 Watts mounted up to 24 feet when used with a RAB photo/motion control. Select a photo/motion control using catalog number STL110, STL200 or STL360. Mounting heights greater than 24 feet require only a photocell. See FXLED200SF/PCS or FXLED200SF/PCS2 (277V) for photocell versions.

Replacement:

The FXLED200 replaces 400W Metal Halide Floodlights.

Warranty:

RAB warrants that our LED products will be free from defects in materials and workmanship for a period of five (5) years from the date of delivery to the end user, including coverage of light output, color stability, driver performance and fixture finish.

Country of Origin:

Designed by RAB in New Jersey and assembled in the USA by RAB's IBEW Local 3 workers.

Buy American Act Compliant:

This product is a COTS item manufactured in the United States, and is compliant with the Buy American Act.

Technical Specifications (continued)

Other

Recovery Act (ARRA) Compliant:

This product complies with the 52.225-21 "Required Use of American Iron, Steel, and Manufactured Goods-- Buy American Act-- Construction Materials (October 2010).

Trade Agreements Act Compliant:

This product is a COTS item manufactured in the United States, and is compliant with the Trade Agreements Act.

GSA Schedule:

Suitable in accordance with FAR Subpart 25.4.

FXLED200 with Bi-Level Operation:

Allows 50% and 100% output modes.

FXLED200SFYB46/BL



Dimensions

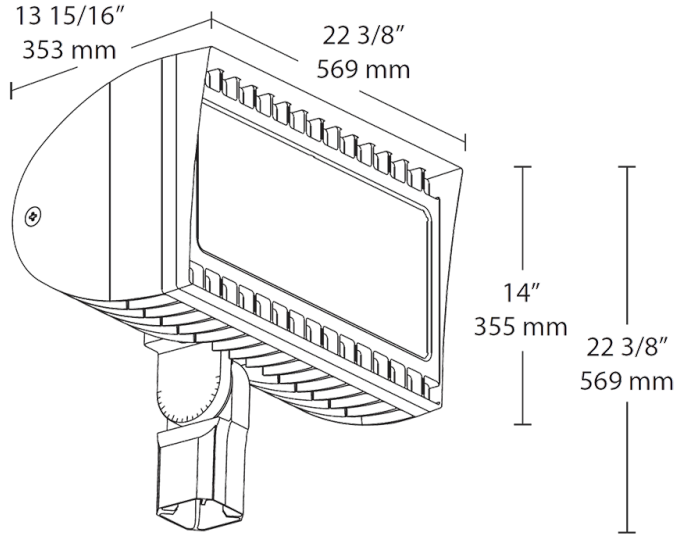

Features

- 200W replaces 400 MH floodlights
- 100,000-hour LED lifespan
- 5-year No Compromise Warranty

Ordering Matrix

Family	Watts	Mount	Color Temp	Beam Spread	Finish	Dimming	Voltage	Photocell	Bi-Level
FXLED	200 = 200W	SF = Slipfitter T = Trunnion	Blank = 5000K (Cool) Y = 3000K (Warm) N = 4000K (Neutral)	Blank = 7H x 6V B64 = 6H x 4V B55 = 5H x 5V B46 = 4H x 6V B44 = 4H x 4V B33 = 3H x 3V	Blank = Bronze W = White	Blank = No Dimming /D10 = Dimmable	Blank = 120-277V /480 = 480V	Blank = No Photocell /PCS = 120V Swivel /PCS2 = 277V Swivel /PCS4 = 480V Swivel /PCT = 120-277V Twistlock /PCT4 = 480V Twistlock	Blank = No Bi-Level /BL = Bi-Level