



18 Watt LED floodlight with emergency Backup battery that will last for 90 minutes during power interruption. Designed to replace 70W metal halide. Patented airflow technology ensures long LED and driver lifespan. 5 year warranty.

Color: White

Weight: 13.3 lbs

Project:	Type:
Prepared By:	Date:

Driver Info		LED Info	
Type:	Constant Current	Watts:	18W
120V:	0.2A	Color Temp:	5000K
208V:	0.15A	Color Accuracy:	72 CRI
240V:	0.13A	L70 Lifespan:	100000
277V:	0.11A	Lumens:	2,310
Input Watts:	23W	Efficacy:	100 LPW
Efficiency:	78%		

Technical Specifications

Other

FFLED18 with Battery Backup:

Minimum starting temperature is 0°C/32°F.

Equivalency:

The FFLED18 is Equivalent in delivered lumens to a 70W Metal Halide.

California Title 24:

FFLED18 complies with California Title 24 building and electrical codes.

Warranty:

RAB warrants that our LED products will be free from defects in materials and workmanship for a period of five (5) years from the date of delivery to the end user, including coverage of light output, color stability, driver performance and fixture finish.

Patents:

The FFLED design is protected by U.S. Pat. D643,147, Canada Pat. 140798, China Pat. ZL201130171304.1, Mexico Pat. 36757 and pending patent in Taiwan.

Country of Origin:

Designed by RAB in New Jersey and assembled in the USA by RAB's IBEW Local 3 workers.

Buy American Act Compliant:

This product is a COTS item manufactured in the United States, and is compliant with the Buy American Act.

Recovery Act (ARRA) Compliant:

This product complies with the 52.225-21 "Required Use of American Iron, Steel, and Manufactured Goods-- Buy American Act-- Construction Materials (October 2010).

Trade Agreements Act Compliant:

This product is a COTS item manufactured in the United States, and is compliant with the Trade Agreements Act.

GSA Schedule:

Suitable in accordance with FAR Subpart 25.4.

American Bureau of Shipping (ABS) :

For use on Mobile Offshore Drilling Units (MODU) and shipping vessels.

Listings

UL Listing:

Suitable for Wet Locations. Wall Mount Only. Battery Backup UL 924 Listed Emergency Lighting Power Supply.

IESNA LM-79 & LM-80 Testing:

RAB LED luminaires have been tested by an independent laboratory in accordance with IESNA LM-79 and LM-80, and have received the Department of Energy "Lighting Facts" label.

Optical

Lumen Maintenance:

100,000-hour LED lifespan based on IES LM-80 results and TM-21 calculations.

NEMA Type:

NEMA Beam Spread of 7H x 6V

Construction

IP Rating:

Ingress Protection rating of IP65 for dust and water.

Thermal Management:

Optimized using computational fluid dynamics software to ensure long LED and driver lifespan.

Gaskets:

High temperature silicone.

Housing:

Precision die-cast aluminum housing, lens frame and mounting arm.

Airflow:

Patent pending Airflow technology heat sink for superior cooling.

Thermal Management Housing:

Die-cast aluminum housing, lens frame and mounting arm.

Mounting:

Heavy-duty mounting arm with "O" ring seal & stainless steel screw.

Reflector:

Semi-specular anodized aluminum.

Gaskets:

High-temperature silicone gaskets.

Finish:

Our environmentally friendly polyester powder coatings are formulated for high-durability and long-lasting color, and contains no VOC or toxic heavy metals.

Green Technology:

Mercury and UV free. RoHS compliant components. Polyester powder coat finish formulated without the use of VOC or toxic heavy metals.

Technical Specifications (continued)

LED Characteristics

LEDs:

Multi-chip, high-output, long-life LEDs

Color Consistency:

7-step MacAdam Ellipse binning to achieve consistent fixture-to-fixture color.

Color Stability:

LED color temperature is warranted to shift no more than 200K in CCT over a 5 year period.

Color Uniformity:

RAB's range of CCT (Correlated Color Temperature) follows the guidelines of the American National Standard for (SSL) Products, ANSI C78.377-2015.

Electrical

Driver:

Constant Current, Class 2, 50/60 Hz, 120 - 277VAC
0.4 Amps.

THD:

9.5% at 120V, 9.9% at 277V

Power Factor:

99.4% at 120V, 96.2% at 277V

Surge Protection:

6kV

Battery Backup

Backup Battery:

Two field-replaceable, high-temperature, maintenance-free, nickel-cadmium batteries.

Dimensions

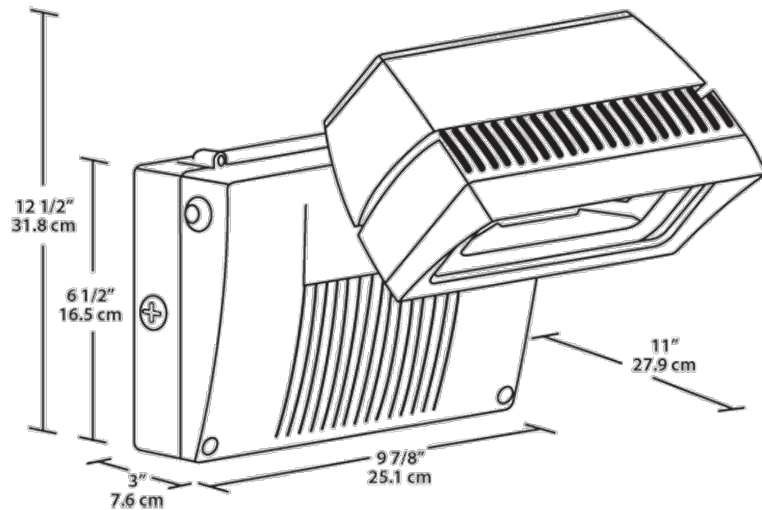

Features

- Backup battery UL924 listed
- UL listed for wet locations
- 90 minutes illumination time during power interruption
- Includes test switch and charge indicator light
- Universal input voltage
- 5 year warranty

Ordering Matrix

Family	Watts	Color Temp	Finish	Battery Backup
FFLED	18 = 18W	Blank = 5000K (Cool) Y = 3000K (Warm) N = 4000K (Neutral)	Blank = Bronze W = White	/E = Battery Backup /EC = Cold Start Battery Backup