



Color: Brushed nickel

Weight: 4.4 lbs

Project:	Type:
Prepared By:	Date:

Driver Info		LED Info	
Type	Constant Current	Watts	32W
120V	0.30A	Color Temp	2700/3000/3500/4000/5000K
208V	0.16A	Color Accuracy	90 CRI
240V	0.14A	L70 Lifespan	50,000 Hours
277V	0.13A	Lumens	2,200
Input Watts	32W	Efficacy	68.8

Technical Specifications

Performance

Product Type:

Surface & Flush Mounts

Input Wattage:

32W

Lumens (Nominal):

2200lm

Efficacy:

68.8 lm/W

L70 Lifespan:

50,000-Hour LED lifespan based on IES LM-70 results

R9 Value:

High color performance with R9 greater than or equal to 50

Compliance

UL Listed:

Suitable for wet locations

ENERGY STAR V2.2:

This product is ENERGY STAR® Version 2.2 Certified.

Energy Star ID:

2389833

Electrical

Dimming Driver:

Driver includes dimming control wiring for 0-10V dimming systems. Requires separate 0-10V DC dimming circuit. Dims down to 10%.

THD:

≤20%

Power Factor:

≥0.9

Input Voltage:

120-277V

Operating Frequency:

50/60Hz

Technical Specifications (continued)

Construction

Material:

Metal and Plastic

Trim Style:

Smooth Trim

Shape:

Round

Beam Angle:

130°

Mounting:

Surface mount

Operating Temperature:

-20°C (-4°F) to 40°C (104°F)

Size:

18"

Electrical Characteristics

Flicker:

≤30%

Other

Warranty:

RAB warrants that our LED products will be free from defects in materials and workmanship for a period of five (5) years from the date of delivery to the end user, including coverage of light output, color stability, driver performance and fixture finish. RAB's warranty is subject to all terms and conditions found at rablighting.com/warranty.

Buy American Act Compliance:

RAB values USA manufacturing! Upon request, RAB may be able to manufacture this product to be compliant with the Buy American Act (BAA). Please contact customer service to request a quote for the product to be made BAA compliant.

Dimensions

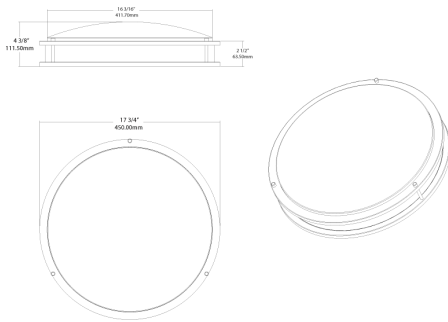

Features

- Stylish surface mount fixture mounts directly to ceiling or wall junction box
- Field-adjustable "set and forget" color temperature
- Diffuse lens provides soft, smooth light
- Durable construction protects against breakage
- Ideal for hospitality and multi-family residential applications
- Suitable for wet locations

Ordering Matrix

Family	Type	Size	Shape	Wattage	CRI/Color Temp	Voltage	Finish	Sensor
CRVFA	D	18	R	32	9CCT	UNV	BN	/MVS
	S = Smooth D = Decorative	11 = 11" 12 = 12" 14 = 14" 18 = 18" 19 = 19"	R = Round	16 = 16W 20 = 20W 32 = 32W	9CCT = 90 CRI, CCT Selectable	120 = 120V UNV = 120-277V	W = White BN = Brushed Nickel	Blank = No Sensor /MVS = Microwave Occupancy Sensor