

product

High performance ceiling mounted LED lighting with mini sensor. Bi-level option available. Flush mount fixture bracket.

Color: White

Weight: 6.6 lbs

Project:

Type:

Prepared By:

Date:

Driver Info

Type: Constant Current
 120V: 0.6A
 208V: N/A
 240V: N/A
 277V: N/A
 Input Watts: 31W
 Efficiency: 85%

LED Info

Watts: 26W
 Color Temp: 3000K
 Color Accuracy: 86 CRI
 L70 Lifespan: 100000
 Lumens: 1,281
 Efficacy: 42 LPW

Technical Specifications

Other

Bi-Level(BL) Operation:

Bi-Level option supplies a fixture with the sensor(s) wired to control only one fixture leaving the other fixture always on or available for timer or photo sensor control by customer. Two sets of labeled leads will be provided.

Thermal Management (Patent Pending):

Die-cast aluminum Thermal Management system for optimal heat dissipation.

Patents:

RAB CLED2X13 are protected by patents in US pat. D615,689 CN ZL201030129125 MX 32130 TW pat. D139033.

Warranty:

RAB warrants that our LED products will be free from defects in materials and workmanship for a period of five (5) years from the date of delivery to the end user, including coverage of light output, color stability, driver performance and fixture finish.

California Title 24:

CLED complies with California Title 24 building and electrical codes.

Country of Origin:

Designed by RAB in New Jersey and assembled in the USA by RAB's IBEW Local 3 workers.

Buy American Act Compliant:

This product is a COTS item manufactured in the United States, and is compliant with the Buy American Act.

Recovery Act (ARRA) Compliant:

This product complies with the 52.225-21 "Required Use of American Iron, Steel, and Manufactured Goods-- Buy American Act-- Construction Materials (October 2010).

Trade Agreements Act Compliant:

This product is a COTS item manufactured in the United States, and is compliant with the Trade Agreements Act.

GSA Schedule:

Suitable in accordance with FAR Subpart 25.4.

Listings

UL Listing:

Suitable for damp locations.

IESNA LM-79 & IESNA LM-80 Testing:

RAB LED luminaires have been tested by an independent laboratory in accordance with IESNA LM-79 and LM-80, and have received the Department of Energy "Lighting Facts" label.

LED Characteristics

Lifespan:

100,000-hour LED lifespan based on IES LM-80 results and TM-21 calculations.

LEDs:

(2) 13W Multi-chip high-output, long-life LED.

Color Consistency:

3-step MacAdam Ellipse binning to achieve consistent fixture-to-fixture color.

Color Stability:

LED color temperature is warranted to shift no more than 200K in CCT over a 5 year period.

Color Uniformity:

RAB's range of CCT (Correlated color temperature) follows the guidelines of the American National Standard for Specifications for the Chromaticity of Solid State Lighting (SSL) Products, ANSI C78.377-2011.

Color Accuracy:

86 CRI

Color Temperature (Nominal CCT):

4000K

Construction

Recommended Mounting Height:

8-10'.

Cold Weather Starting:

Minimum starting temperature is -40°F/-40°C.

Maximum Ambient Temperature:

Suitable for use in 40°C (104°F) ambient temperatures

Housing:

Precision die cast aluminum housing and lens framing.

Gaskets:

High-temperature silicone

Finish:

Our environmentally friendly polyester powder coatings are formulated for high-durability and long-lasting color, and contains no VOC or toxic heavy metals.

Green Technology:

Mercury and UV free. RoHS compliant components. Polyester powder coat finish formulated without the use of VOC or toxic heavy metals.

Technical Specifications (continued)

Electrical

Drivers (2):

Constant Current, Class 2, 100V-277V, 50/60 Hz, 4kv Surge Protection, 720mA, 100-240VAC 0.3-0.15 Amps, 277VAC 0.3 Amps, THD less than equal to 20%, Power Factor 97.5%.

Voltage:

120 volts AC 60 Hz.

Optical

Fixture Efficacy:

42 Lumens per Watt

Sensor Characteristics

Sensor Switching Capacity:

5 Amps, 450 Watts LED @ 120 Volts 0.8pF Driver; 5 Amps, 300 Watts LED @ 120 Volts 0.5pF Driver.

Sensor Time Adjustment:

5 seconds to 15 minutes.

Sensor Quick Test Time:

5 second test time for fast installation. Works day or night.

Sensor "No Hands" Auto Testing:

Auto mode starts after 4 minutes of testing. No adjustment needed.

Sensor Photoelectric Control:

Deactivates lights during daylight. Fully adjustable for 24 hour operation or custom applications.

Sensor LED Detection Indicator:

LED glows red day & night for "on guard" deterrence.

Sensor RF Immunity:

Circuits fully shielded for maximum radio frequency immunity.

Sensor Ratings:

5 amps.

Sensor Power Consumption:

Negligible

Sensor Manual Switch:

None.

Sensor Ambient Light Sensing:

Adjustable.

Sensor Adjustments:

Time, ambient light & sensitivity.

Sensor Detection:

180° detection pattern.

Dimensions

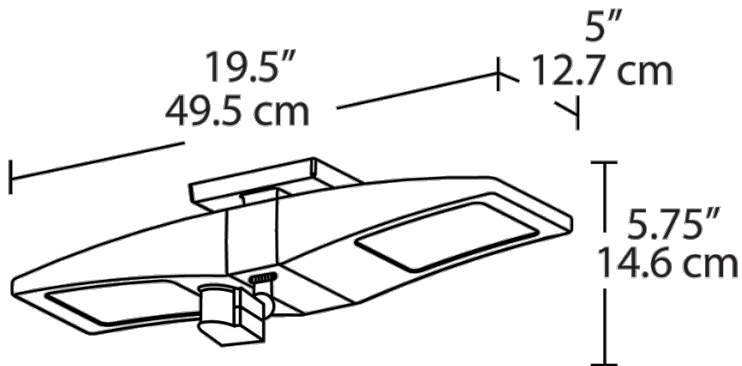

Features

- Reduce energy usage with motion sensor technology you can rely on
- LED combined with mini sensor for an all-in-one lighting solution
- Great for small spaces like utility closets and storage rooms
- 5 year warranty