



Two adjustable 12W LED floodlights. Equivalent to 2x75W BR30/halogen/wide floods. Microprismatic diffusion lens optimizes light output without glare.

Color: Bronze

Weight: 6.3 lbs

Project:

Type:

Prepared By:

Date:

Driver Info

Type: Constant Current
 120V: 0.22A
 208V: N/A
 240V: N/A
 277V: N/A
 Input Watts: 26W
 Efficiency: 91%

LED Info

Watts: 24W
 Color Temp: 3000K
 Color Accuracy: 83 CRI
 L70 Lifespan: 100000
 Lumens: 1,600
 Efficacy: 61 LPW

Technical Specifications

Listings

UL Listing:

Suitable for wet locations

IESNA LM-79 & LM-80 Testing:

RAB LED luminaires have been tested by an independent laboratory in accordance with IESNA LM-79 and LM-80, and have been received the Department of Energy "Lighting Facts" label.

LED Characteristics

LEDs:

Multi-chip, high-output, long-life LEDs

Lifespan:

100,000-Hour LED lifespan based on IES LM-80 results and TM-21 calculation

Color Stability:

LED color temperature is warranted to shift no more than 200K in CCT over a 5 year period.

Color Uniformity:

RAB's range of CCT (Correlated Color Temperature) follows the guidelines of the American National Standard for Specifications for the Chromaticity of Solid State Lighting (SSL) Products, ANSI C78.377-2011.

Electrical

Driver:

Innovative integrated driver technology with 120V TRIAC and ELV dimming

Construction

Thermal Management:

Superior heat sinking with external Air-Flow fins

Housing:

Die-cast aluminum housing, lens frame and mounting plate

Reflector:

Semi-specular, vacuum-metalized polycarbonate

Lens:

Microprismatic diffusion lens for smooth and even light distribution

Mounting:

Heavy-duty mounting arm with "O" ring seal and stainless steel screws

Gaskets:

High-temperature silicone gaskets

Finish:

Our environmentally friendly polyester powder coatings are formulated for high-durability and long-lasting color, and contain no VOC or toxic heavy metals.

Green Technology:

Mercury and UV free. RoHS compliant components. Polyester powder coat finish formulated without the use of VOC or toxic heavy metals.

Other

California Title 24:

BULLET2x12 complies with 2013 California Title 24 building and electrical codes as a residential outdoor lighting fixture with no additional hardware required and as a commercial outdoor non-pole-mounted fixture ≤ 30 Watts when used with a photosensor control. Select catalog number to order a photosensor.

Warranty:

RAB warrants that our LED products will be free from defects in materials and workmanship for a period of five (5) years from the date of delivery to the end user, including coverage of light output, color stability, driver performance and fixture finish.

BULLET2X12YA

Dimensions

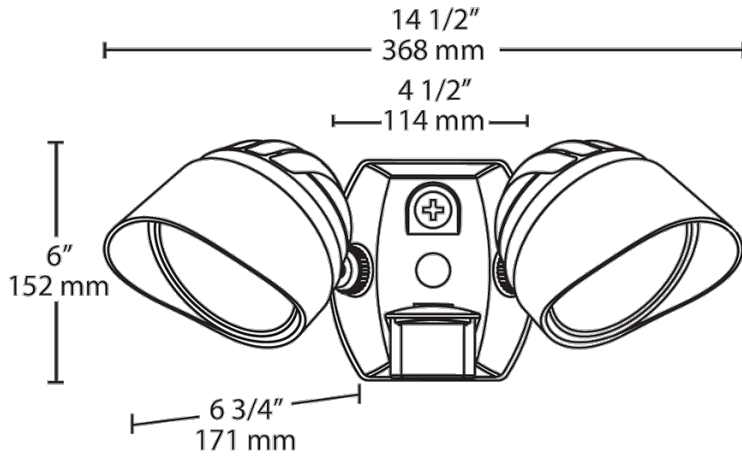

Features

- Two adjustable 12W LED floodlights
- Equivalent to 2x75W BR30/halogen/wide floods
- Microprismatic diffusion lens optimizes light output without glare
- 100,000-hour LED Lifespan

Ordering Matrix

Family	Heads	Watts	Color Temp	Finish
BULLET	2x = 2 Heads	12 = 12W	Y = 3000K (Warm)	A = Bronze B = Black VG = Verde Green W = White