

Performance Area Light with wall mount. Mounting arm is 10" long. Tether included for support during installation. Factory wired for 277V. Lamp supplied.

Color: Bronze

Weight: 41.2 lbs

Project:	Type:
Prepared By:	Date:

Lamp Info		Ballast Info	
Type:	ED28	Type:	CWA HPF QT
Watts:	400W	120V:	3.5/4.0A
Shape/Size:	N/A	208V:	N/A
Base:	N/A	240V:	N/A
ANSI:	N/A	277V:	N/A
Hours:	20,000	Input Watts:	450W
Lamp Lumens:	40,000	Efficiency:	89%
Efficacy:	89 LPW		

Technical Specifications

Listings

UL Listing:

Suitable for wet locations. Suitable for mounting within 1.2m (4ft) of the ground.

Electrical

Photocell:

120V Button Photocell Included. Photocell is only compatible with 120V.

Socket:

Porcelain socket pulse rated 4kv, 1500 watts and 600 volts, reinforced with cat's eyes for added durability. Silicone and fiberglass #14 gauge socket leads rated for 200°C. Plated screw shell designed to resist corrosion with spring loaded center contact.

Construction

Lens Gasket:

EPDM gasket seals optical chamber preventing dirt and rust.

Housing:

One-piece precision die cast aluminum with die cast door frame.

Reflector:

Hydroformed reflector.

Finish:

Our environmentally friendly polyester powder coatings are formulated for high-durability and long-lasting color, and contains no VOC or toxic heavy metals.

Lens:

Thermal, tempered shock resistant glass, 5/32" thick.

Mounting Arm:

Mounts with two 3/8 threaded rods at 2" on center.

EPA:

1.8.

Other

Patents:

The design of the ALX Area Light is protected by U.S. patent D591,445, Canada Patent D127,045, Mexico Patent 28577 and patents pending in the U.S., China and Taiwan.

Country of Origin:

Designed by RAB in New Jersey and assembled in the USA by RAB's IBEW Local 3 workers.

Buy American Act Compliant:

This product is a COTS item manufactured in the United States, and is compliant with the Buy American Act.

Recovery Act (ARRA) Compliant:

This product complies with the 52.225-21 "Required Use of American Iron, Steel, and Manufactured Goods-- Buy American Act-- Construction Materials (October 2010).

Trade Agreements Act Compliant:

This product is a COTS item manufactured in the United States, and is compliant with the Trade Agreements Act.

GSA Schedule:

Suitable in accordance with FAR Subpart 25.4.

Dimensions

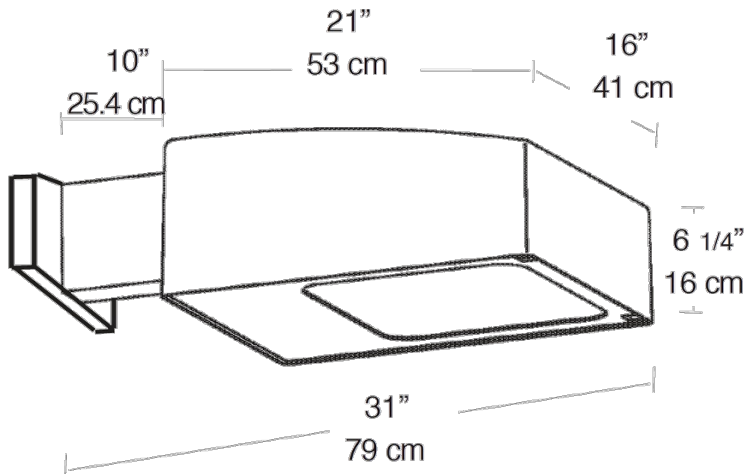

Features

- Field rotatable optics
- Custom Hydroformed reflector
- Sleek smaller volume design lowers EPA
- Sealed optical chamber
- Stainless steel external hardware
- Silicone lamp retainer keeps lamp in socket
- Lamp supplied