



Project:	Type:
Prepared By:	Date:

Lamp Info		Ballast Info	
Type:	ED28	Type:	CWA HPF QT
Watts:	400W	120V:	N/A
Shape/Size:	N/A	208V:	2.0/2.3A
Base:	N/A	240V:	1.8/2.0A
ANSI:	N/A	277V:	1.5/1.8A
Hours:	20,000	Input Watts:	450W
Lamp Lumens:	40,000	Efficiency:	89%
Efficacy:	89 LPW		

Technical Specifications

Electrical

Photocell:

277V Photocell Included. Photocell is compatible with 208V-277V.

Socket:

Porcelain socket pulse rated 4kv, 1500 watts and 600 volts, reinforced with cat's eyes for added durability. Silicone and fiberglass #14 gauge socket leads rated for 200C. Plated screw shell designed to resist corrosion with spring loaded center contact.

Listings

UL LISTING:

Suitable for wet locations. Suitable for mounting within 1.2m (4ft) of the ground.

Dark Sky Approved:

The International Dark Sky Association has approved this product as a full cutoff, fully shielded luminaire.

EISA 2007 Compliant:

This product complies with the new law for metal halide ballast efficiency. This law goes into effect January 1st, 2008. Pulse Start offers Longer Lamp Life, Faster Startup and Faster Restrike.

Construction

Lens Gasket:

High temperature extruded silicone set in die cast retaining groove. Remains in place during relamping.

Housing:

One-piece precision die cast aluminum housing and door held captive when opened. Removable hinge pins for door removal.

Reflector:

Hydroformed Type II reflector.

Finish:

Our environmentally friendly polyester powder coatings are formulated for high-durability and long-lasting color, and contains no VOC or toxic heavy metals.

Lens:

Thermal, tempered shock resistant glass, 5/32" thick.

Mounting Arm:

Mounts with two 5/16 -18 threaded rods at 2" on center.

EPA:

1

Other

Patents:

Sensor and fixture designs are protected under U.S. and International Intellectual Property Laws.

Country of Origin:

Designed by RAB in New Jersey and assembled in the USA by RAB's IBEW Local 3 workers.

Buy American Act Compliant:

This product is a COTS item manufactured in the United States, and is compliant with the Buy American Act.

Recovery Act (ARRA) Compliant:

This product complies with the 52.225-21 "Required Use of American Iron, Steel, and Manufactured Goods-- Buy American Act-- Construction Materials (October 2010).

Trade Agreements Act Compliant:

This product is a COTS item manufactured in the United States, and is compliant with the Trade Agreements Act.

GSA Schedule:

Suitable in accordance with FAR Subpart 25.4.

Dimensions

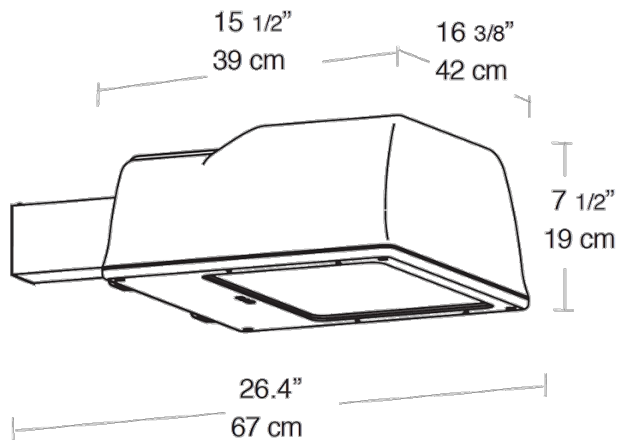

Features

- Fins dissipate heat outside the ballast compartment
- Hydroformed type II reflector for superior optic control
- Capacitor cradle dissipates heat and extends lamp and ballast life
- Stainless steel external hardware
- Fixed arm for pole mounting or slipfitter mount
- Silicone gasket for durable weatherproofing & easy relamping
- Lamp supplied