



High output LED pole top area light with IES type V circular distribution. Wide and uniform 360 degree pattern ideal for large outdoor areas such as parking lots, corporate parks, and retail settings.

Color: White

Weight: 21.8 lbs

Project:	Type:
Prepared By:	Date:

Driver Info		LED Info	
Type:	Constant Current	Watts:	52W
120V:	0.49A	Color Temp:	5000K
208V:	0.31A	Color Accuracy:	64 CRI
240V:	0.27A	L70 Lifespan:	100000
277V:	0.24A	Lumens:	4,877
Input Watts:	59W	Efficacy:	82 LPW
Efficiency:	88%		

Technical Specifications

Electrical

Dimming Driver:

Driver includes dimming control for 0-10V dimming systems. Requires separate 0-10V DC dimming circuit. Dims as low as 10%.

Drivers (2):

Constant Current, 720mA, Class 2 with 6kV surge protection, 100-277VAC, 50/60 Hz.

THD:

7.9% at 120V, 11.3% at 277V

Listings

UL Listing:

Suitable for wet locations.

IESNA LM-79 & LM-80 Testing:

RAB LED luminaires have been tested by an independent laboratory in accordance with IESNA LM-79 and LM-80, and have received the Department of Energy "Lighting Facts" label.

LED Characteristics

LEDs:

4x13W high-output, long-life LEDs.

Lifespan:

100,000-hour LED lifespan based on IES LM-80 results and TM-21 calculations.

Color Consistency:

7-step MacAdam Ellipse binning to achieve consistent fixture-to-fixture color.

Color Stability:

LED color temperature is warranted to shift no more than 200K in CCT over a 5 year period.

Color Uniformity:

RAB's range of CCT (Correlated Color Temperature) follows the guidelines of the American National Standard for Specifications for the Chromaticity of Solid State Lighting (SSL) Products, ANSI C78.377-2011.

Construction

Cold Weather Starting:

Minimum starting temperature is -40°F / -40°C

Maximum Ambient Temperature:

Suitable for use in 40°C (104°F) ambient temperatures

Effective Projected Area:

EPA = 1.2

Thermal Management:

Superior thermal management with external air-flow fins

Housing:

Precision die-cast aluminum, Type V distribution.

Support Arms:

Extruded aluminum.

Lens:

Clear tempered glass lens.

Reflector:

Specular vacuum-metallized polycarbonate, Type V distribution.

Gaskets:

High-temperature silicone

Finish:

Our environmentally friendly polyester powder coatings are formulated for high-durability and long-lasting color, and contains no VOC or toxic heavy metals.

Green Technology:

Mercury and UV free. RoHS compliant components. Polyester powder coat finish formulated without the use of VOC or toxic heavy metals.

Other

Buy American Act Compliant:

This product is a COTS item manufactured in the United States, and is compliant with the Buy American Act.

Recovery Act (ARRA) Compliant:

This product complies with the 52.225-21 "Required Use of American Iron, Steel, and Manufactured Goods-- Buy American Act-- Construction Materials (October 2010).

Trade Agreements Act Compliant:

This product is a COTS item manufactured in the United States, and is compliant with the Trade Agreements Act.

GSA Schedule:

Suitable in accordance with FAR Subpart 25.4.

Patents:

The designs of the ALED5T52 are protected by patents pending in US, Canada, China, Taiwan and Mexico.

Technical Specifications (continued)

Optical

BUG Rating:

B3 U1 G1

Dimensions

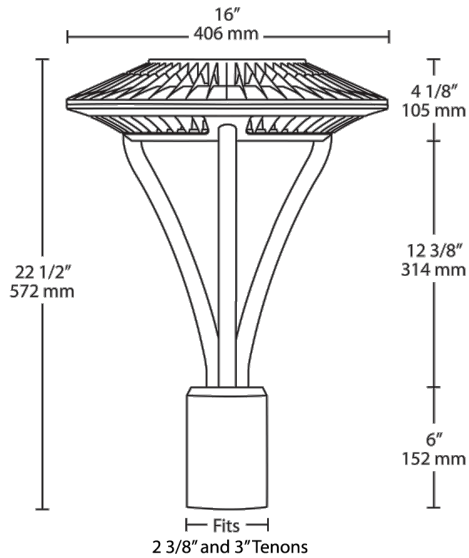

Features

- IES type V (circular) distribution
- 100,000-hour LED lifespan
- Compatible with standard 2 3/8" and 3" tenons
- Air-flow fins for maximum heat dissipation
- 5-year warranty

Ordering Matrix

Family	Distribution	Watts	Color Temp	Finish	Dimming	Bi-Level
ALED	5T = Type V	78 = 78W 52 = 52W 26 = 26W	Blank = 5000K (Cool) Y = 3000K (Warm) N = 4000K (Neutral)	Blank = Bronze W = White	Blank = No Dimming /D10 = Dimmable	Blank = No Bi-Level /BL = Bi-Level