



Specification grade area lights available with IES Type III distribution. For use for roadway, general parking and other area lighting applications where a larger pool of lighting is required. Patent pending thermal management system. 5 Year Warranty.

Color: Bronze

Weight: 75.0 lbs

Project:	Type:
Prepared By:	Date:

Driver Info		LED Info	
Type:	Constant Current	Watts:	260W
120V:	2.2A	Color Temp:	4000K
208V:	1.3A	Color Accuracy:	71 CRI
240V:	1.1A	L70 Lifespan:	100000
277V:	1.0A	Lumens:	26,734
Input Watts:	253W	Efficacy:	105 LPW
Efficiency:	N/A		

Technical Specifications

Listings

UL Listing:

Suitable for wet locations.

IESNA LM-79 & LM-80 Testing:

RAB LED luminaires have been tested by an independent laboratory in accordance with IESNA LM-79 and LM-80, and have been received the Department of Energy "Lighting Facts" label.

LED Characteristics

Lifespan:

100,000-hour LED lifespan based on IES LM-80 results and TM-21 calculations.

LEDs:

Multi-chip, high-output, long-life LEDs

Color Consistency:

7-step MacAdam Ellipse binning to achieve consistent fixture-to-fixture color.

Color Stability:

LED color temperature is warranted to shift no more than 200K in CCT over a 5 year period.

Color Uniformity:

RAB's range of CCT (Correlated Color Temperature) follows the guidelines of the American National Standard for Specifications for the Chromaticity of Solid State Lighting (SSL) Products, ANSI C78.377-2011.

Construction

IES Classification:

The Type III distribution is ideal for roadway, general parking and other area lighting applications where a larger pool of lighting is required. It is intended to be located near the side of the area, allowing the light to project outward and fill the area.

Effective Projected Area:

EPA = 5

Maximum Ambient Temperature:

Suitable for use in 40°C (104°F) ambient temperatures

Cold Weather Starting:

The minimum starting temperature is -40°C/-40°F

Thermal Management:

Superior thermal management with external Air-Flow fins.

Housing:

Die cast aluminum with airflow fins for cooling.

Lens:

Tempered glass

Mounting:

Slipfitter with 180° pivot available for mounting on 2 3/8" tenon.

IP Rating:

Ingress Protection rating of IP66 for dust and water.

Reflector:

Vacuum-metallized polycarbonate

Gaskets:

High-temperature silicone gaskets

Finish:

Our environmentally friendly polyester powder coatings are formulated for high-durability and long-lasting color, and contains no VOC or toxic heavy metals.

Green Technology:

Mercury and UV free. RoHS compliant components. Polyester powder coat finish formulated without the use of VOC or toxic heavy metals.

For use on LEED Buildings:

IDA Dark Sky Approval means that this fixture can be used to achieve LEED Credits for Light Pollution Reduction.

Electrical

Dimming Driver:

Driver includes dimming control wiring for 0-10V dimming systems. Requires separate 0-10V DC dimming circuit. Dims as low as 10%.

Drivers:

Constant Current, Class 1, 1660mA, 100-277V, 50-60Hz, 120V: 2.2A, 208V: 1.3A, 240V: 1.1A, 277V: 1.0A

Surge Protection:

4kV

For areas prone to surges, upgrade to 10kV surge protection.

Photocell:

120V-277V Twistlock Photocell Included. Photocell is compatible with 120V-277V.

Optical

THD:

4.7% at 120V, 7.0% at 277V

Technical Specifications (continued)

Optical

Power Factor:

99.8% at 120V, 96.4% at 277V

BUG Rating:

B1 U0 G5

Other

Buy American Act Compliant:

This product is a COTS item manufactured in the United States, and is compliant with the Buy American Act.

Recovery Act (ARRA) Compliant:

This product complies with the 52.225-21 "Required Use of American Iron, Steel, and Manufactured Goods-- Buy American Act-- Construction Materials (October 2010).

Trade Agreements Act Compliant:

This product is a COTS item manufactured in the United States, and is compliant with the Trade Agreements Act.

GSA Schedule:

Suitable in accordance with FAR Subpart 25.4.

Warranty:

RAB warrants that our LED products will be free from defects in materials and workmanship for a period of five (5) years from the date of delivery to the end user, including coverage of light output, color stability, driver performance and fixture finish.

Dimensions

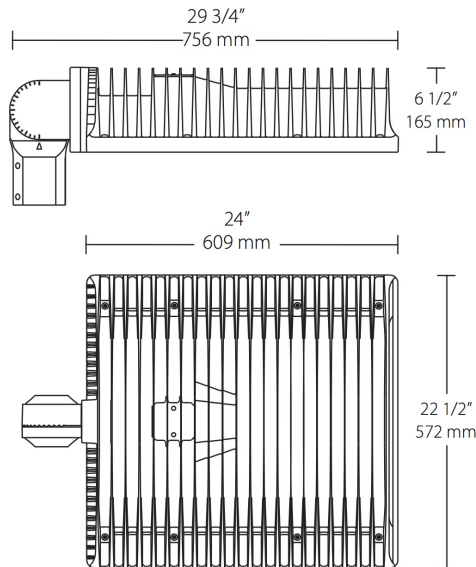

Features

- 66% energy cost savings vs. HID
- 100,000-hour LED lifespan
- Type III distribution
- 5-year warranty

Ordering Matrix

Family	Distribution	Watts	Mount	Color Temp	Finish	Voltage	Photocell	Dimming	Bi-Level
ALED									
	2T = Type II	360 =	Blank =	Blank = 5000K	Blank =	Blank = 120-277V	Blank = No Photocell	Blank = No	Blank = No Bi-
	3T = Type III	360W	Arm	(Cool)	Bronze	/480 = 480V (Only 360W &	/PC = 120V Button	Dimming	Level
	4T = Type IV	260 =	SF =	Y = 3000K	W = White	260W)	/PC2 = 277V Button	/D10 = Dimmable	/BL = Bi-Level
		260W	Slipfitter	(Warm)	RG = Gray		/PCS = 120V Swivel		
		150 =		N = 4000K			/PCS2 = 277V Swivel		
		150W		(Neutral)			/PCT = 120-277V		
		125 =					Twistlock		
		125W					/PCS4 = 480V Swivel		
		105 =					/PCT4 = 480V		
		105W					Twistlock		
		78 = 78W							