



Specification grade area lights available with IES Type II distribution. For use in parking lots, roadways, pathways and general area lighting. Patent pending thermal management system. 5 Year Warranty.

Color: Gray

Weight: 32.0 lbs

Project:	Type:
Prepared By:	Date:

Driver Info		LED Info	
Type:	Constant Current	Watts:	105W
120V:	0.89A	Color Temp:	4000K
208V:	0.58A	Color Accuracy:	82 CRI
240V:	0.50A	L70 Lifespan:	100000
277V:	0.44A	Lumens:	8,377
Input Watts:	106W	Efficacy:	79 LPW
Efficiency:	99%		

Technical Specifications

Listings

UL Listing:

Suitable for wet locations.

IESNA LM-79 & LM-80 Testing:

RAB LED luminaires have been tested by an independent laboratory in accordance with IESNA LM-79 and LM-80, and have been received the Department of Energy "Lighting Facts" label.

LED Characteristics

Lifespan:

100,000-hour LED lifespan based on IES LM-80 results and TM-21 calculations.

LEDs:

Multi-chip, high-output, long-life LEDs

Color Stability:

LED color temperature is warranted to shift no more than 200K in CCT over a 5 year period.

Color Uniformity:

RAB's range of CCT (Correlated Color Temperature) follows the guidelines of the American National Standard for Specifications for the Chromaticity of Solid State Lighting (SSL) Products, ANSI C78.377-2011.

Construction

IES Classification:

The Type II distribution is ideal for wide walkways, on ramps and entrance roadways, bike paths and other long and narrow lighting applications. This type is meant for lighting larger areas and usually is located near the roadside. This type of lighting is commonly found on smaller side streets or jogging paths.

Effective Projected Area:

EPA = 2.2

Maximum Ambient Temperature:

Suitable for use in 40°C (104°F) ambient temperatures

Cold Weather Starting:

The minimum starting temperature is -40°C/-40°F

Thermal Management:

Superior thermal management with external Air-Flow fins.

Housing:

Die-cast aluminum housing, lens frame and mounting arm.

Mounting:

Heavy-duty mounting arm with "O" ring seal & stainless steel screws

Reflector:

Specular vacuum-metallized polycarbonate

Gaskets:

High-temperature silicone gaskets

IP Rating:

Ingress Protection rating of IP66 for dust and water.

Finish:

Our environmentally friendly polyester powder coatings are formulated for high-durability and long-lasting color, and contains no VOC or toxic heavy metals.

Green Technology:

Mercury and UV free. RoHS compliant components. Polyester powder coat finish formulated without the use of VOC or toxic heavy metals.

For use on LEED Buildings:

IDA Dark Sky Approval means that this fixture can be used to achieve LEED Credits for Light Pollution Reduction.

Electrical

Drivers:

Two Drivers, Constant Current, Class 2, 1400mA, 100-277V, 50/60Hz, 0.8A, Power Factor 99%

THD:

5.4% at 120V, 15.4% at 277V

Surge Protection:

4kV

Dimming Driver:

Driver includes dimming control for 0-10V dimming systems. Requires separate 0-10V DC dimming circuit. Dims as low as 10%.

Other

California Title 24:

See ALED2T105/BL, ALED2T105/PCS, ALED2T105/PCS2, or ALED2T105/PCT for a 2013 California Title 24 compliant product. Any additional component requirements will be listed in the Title 24 section under technical specifications on the product page.

Warranty:

RAB warrants that our LED products will be free from defects in materials and workmanship for a period of five (5) years from the date of delivery to the end user, including coverage of light output, color stability, driver performance and fixture finish.

Country of Origin:

Designed by RAB in New Jersey and assembled in the USA by RAB's IBEW Local 3 workers.

Technical Specifications (continued)

Other

Buy American Act Compliant:

This product is a COTS item manufactured in the United States, and is compliant with the Buy American Act.

Recovery Act (ARRA) Compliant:

This product complies with the 52.225-21 "Required Use of American Iron, Steel, and Manufactured Goods-- Buy American Act-- Construction Materials (October 2010).

Trade Agreements Act Compliant:

This product is a COTS item manufactured in the United States, and is compliant with the Trade Agreements Act.

GSA Schedule:

Suitable in accordance with FAR Subpart 25.4.

Optical

BUG Rating:

B1 U0 G2

Dimensions

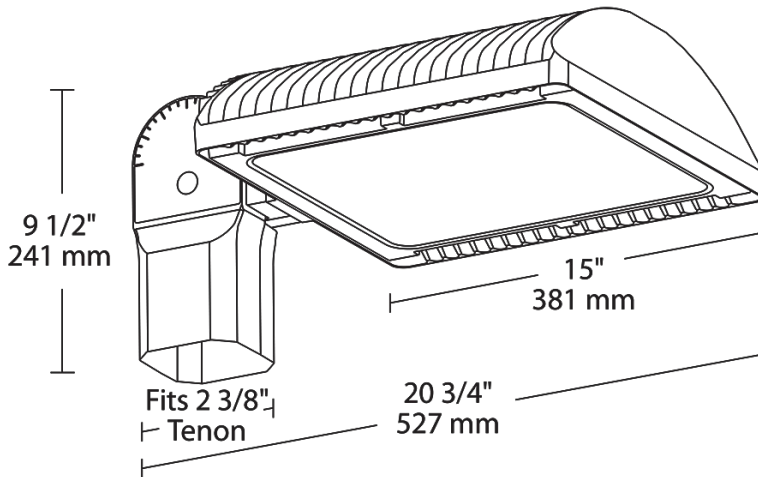

Features

- 66% energy cost savings vs. HID
- 100,000-hour LED lifespan
- Type II distribution
- 5-year warranty

Ordering Matrix

Family	Distribution	Watts	Mount	Color Temp	Finish	Voltage	Photocell	Dimming	Bi-Level
ALED									
	2T = Type II	360 =	Blank =	Blank = 5000K	Blank =	Blank = 120-277V	Blank = No Photocell	Blank = No	Blank = No Bi-
	3T = Type III	360W	Arm	(Cool)	Bronze	/480 = 480V (Only 360W &	/PC = 120V Button	Dimming	Level
	4T = Type IV	260 =	SF =	Y = 3000K	W = White	260W)	/PC2 = 277V Button	/D10 = Dimmable	/BL = Bi-Level
		260W	Slipfitter	(Warm)	RG = Gray		/PCS = 120V Swivel		
		150 =		N = 4000K			/PCS2 = 277V Swivel		
		150W		(Neutral)			/PCT = 120-277V		
		125 =					Twistlock		
		125W					/PCS4 = 480V Swivel		
		105 =					/PCT4 = 480V		
		105W					Twistlock		
		78 = 78W							